

1766893COM CARSON FIREPLACE TV STAND

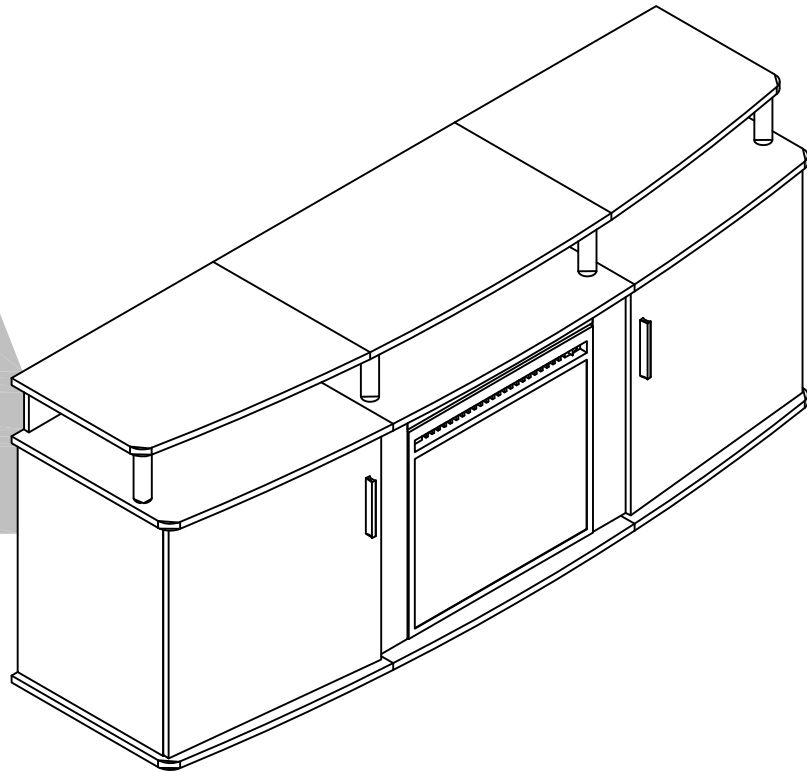

Date of Purchase ___ / ___ / ___
Lot Number:

B341766893COM00KX



THIS INSTRUCTION BOOKLET CONTAINS **IMPORTANT** SAFETY INFORMATION. PLEASE READ AND KEEP FOR FUTURE REFERENCE.

Do Not Return This Product!

Contact our customer service team for help first.

Call: 1-800-489-3351 (toll free)

Monday-Friday 9am - 5pm CST

Visit: www.ameriwoodhome.com

WARNING

- Unit can tip over causing severe injury or death.
- Anchor unit to stud in wall (if instructed to).
- Do Not allow children to climb on unit.
- Put heavy items on lower shelves or drawers.

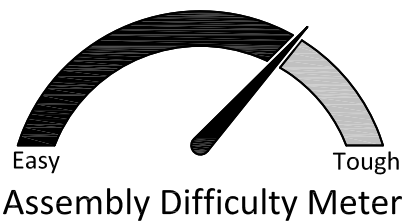

Follow Ameriwood Home



Contact Us!

Do NOT return this product!

Contact our friendly customer service team first for help.

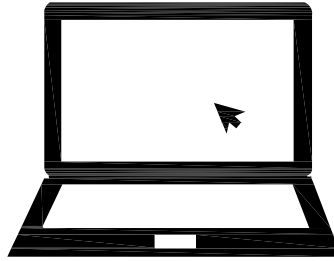

Visit ameriwoodhome.com

Assembly Tips



Helpful Hints

PEOPLE NEEDED FOR ASSEMBLY: 1-2
ESTIMATED ASSEMBLY TIME: 1-2 HOUR

- Open your item in the area you plan to keep it to avoid excessive heavy lifting.
- Identify, sort and count the parts before attempting assembly.
- Compression dowels are lightly tapped in with a hammer.
- Slides are labeled with a **R** (right) and **L** (left) for proper placement.
- Make sure to always face the point on the top of the Cam Lock towards the outer edge.
- Use all the nails provided for the back panel and spread them out equally.
- Back panel must be used to make sure your unit is sturdy.
- Do NOT use harsh chemicals or abrasive cleaners on this item.
- Never push, pull, or drag your furniture.

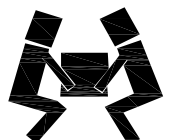
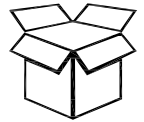

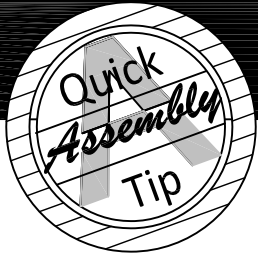

Before You Start

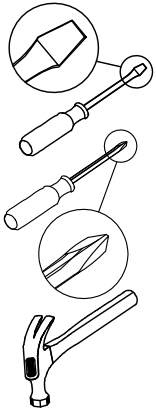

- ✓ Read through each step carefully and follow the proper order
- ✓ Separate and count all your parts and hardware
- ✓ Give yourself enough room for the assembly process
- ✓ Have the following tools: Flat Head Screwdriver, #2 Phillips Head Screwdriver and Hammer
- ✓ Caution: If using a power drill or power screwdriver for screwing, please be aware to slow down and stop when screw is tight. Failure to do so may result in stripping the screw.

Cam Lock Fastening System

This Cam Lock Fastening System will be used throughout the assembly process.

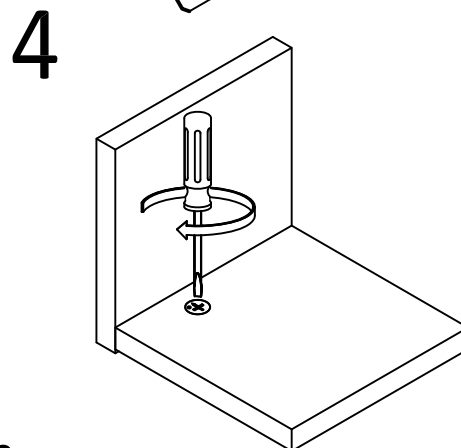
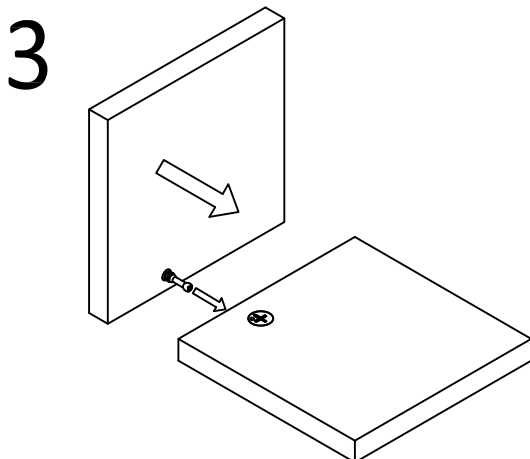
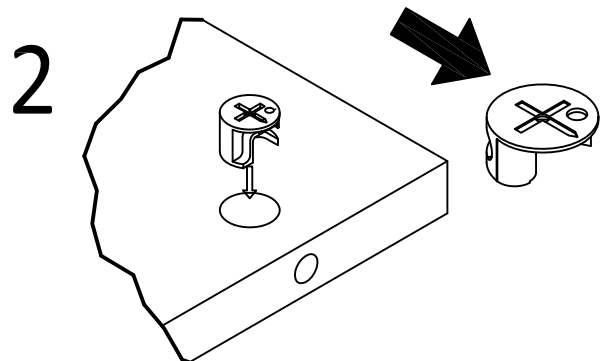
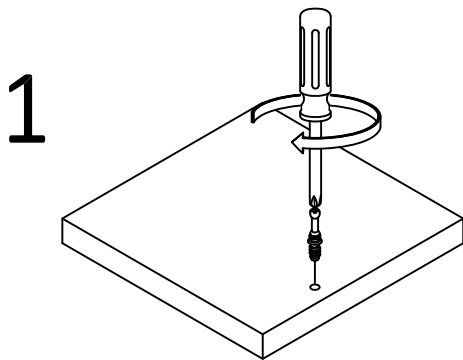

Board Identification

Not Actual Size

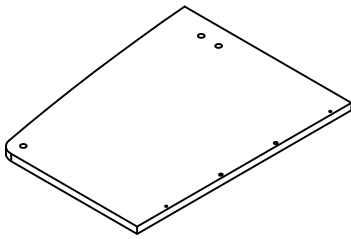

A
Left top
T1766893010KX

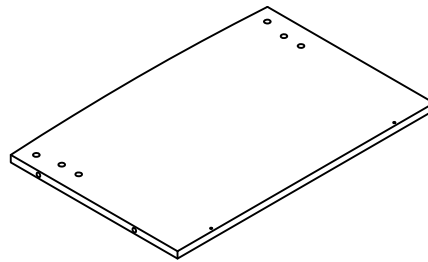

B
Middle top
T1766893020KX

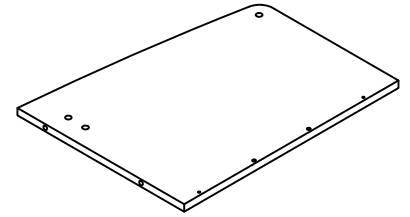

C
Right top
T1766893030KX

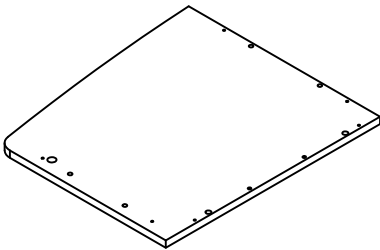

D
Left shelf
T1766893040KX

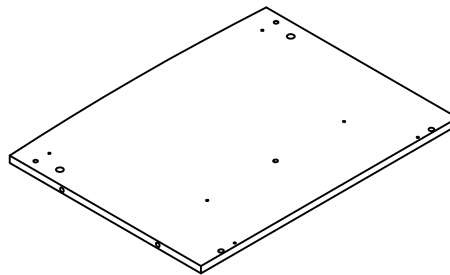

E
Middle shelf
T1766893050KX

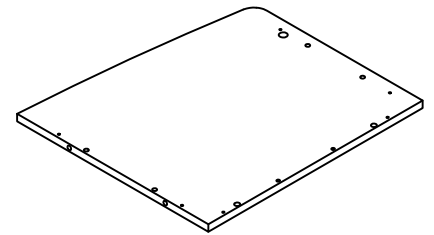

F
Right shelf
T1766893060KX

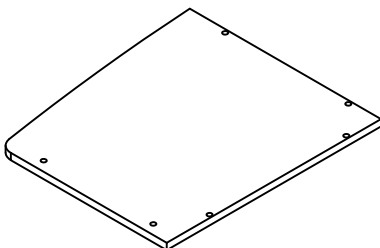

G
Left bottom
T1766893070KX

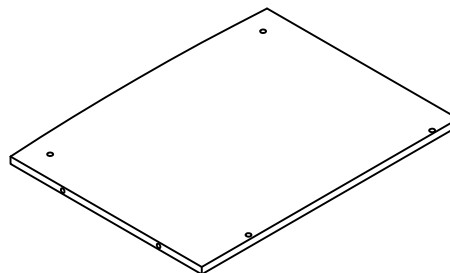

H
Middle bottom
T1766893080KX

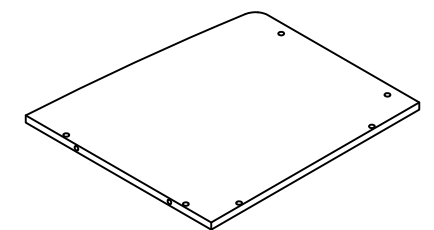

I
Right bottom
T1766893090KX

Board Identification

Not Actual Size

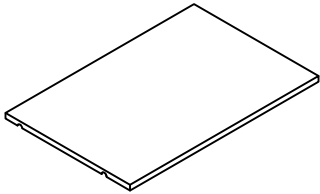

J

Adjustable shelf
T1766893100KX
QTY:2PCS

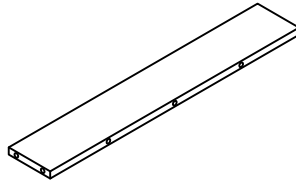

K

Support panel
T1766893110KX

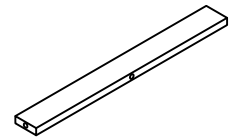

L

Top apron
T1766893120KX

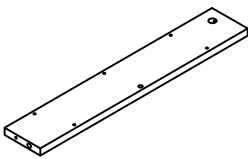

M

Left apron
T1766893130KX

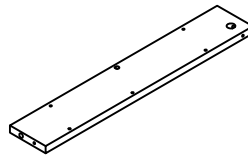

N

Right apron
T1766893140KX

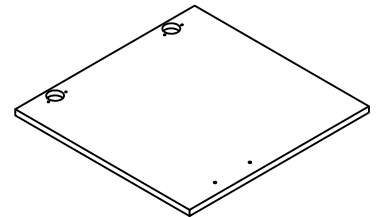

O

Left door
T1766893150KX

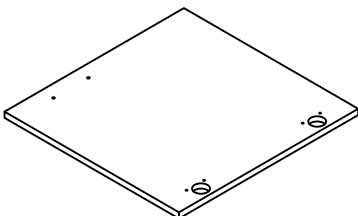

P

Right door
T1766893160KX

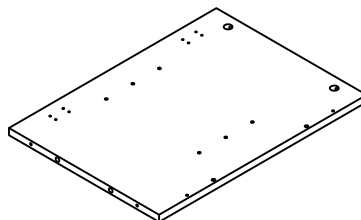

Q

Left side panel
T1766893170KX

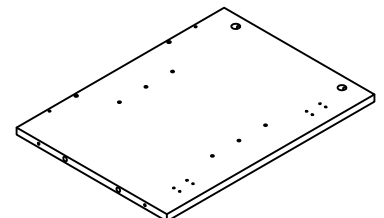

R

Right side panel
T1766893180KX

Board Identification

Not Actual Size

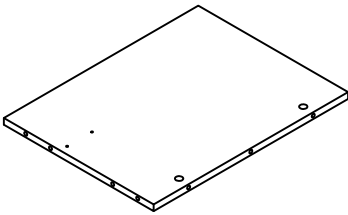

S

Left partition
T1766893190KX

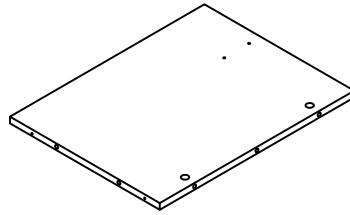

T

Right partition
T1766893200KX

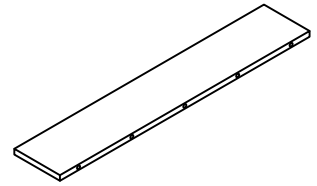

U

Left upper back panel
T1766893210KX

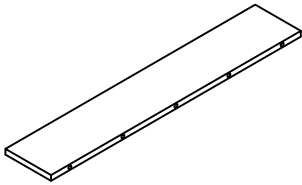

V

Right upper back panel
T1766893220KX

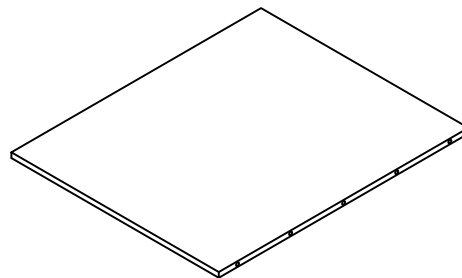

W

Left lower back panel
T1766893230KX

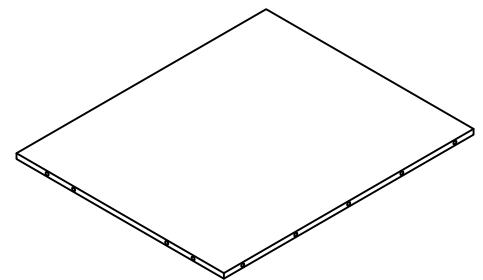

X

Right lower back panel
T1766893240KX



Y

Support tube
T1766893250KX
QTY:4PCS

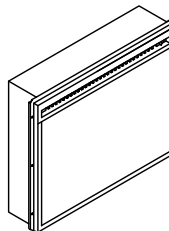

Z

Fireplace insert
F18V66L

Board Identification

Not actual size

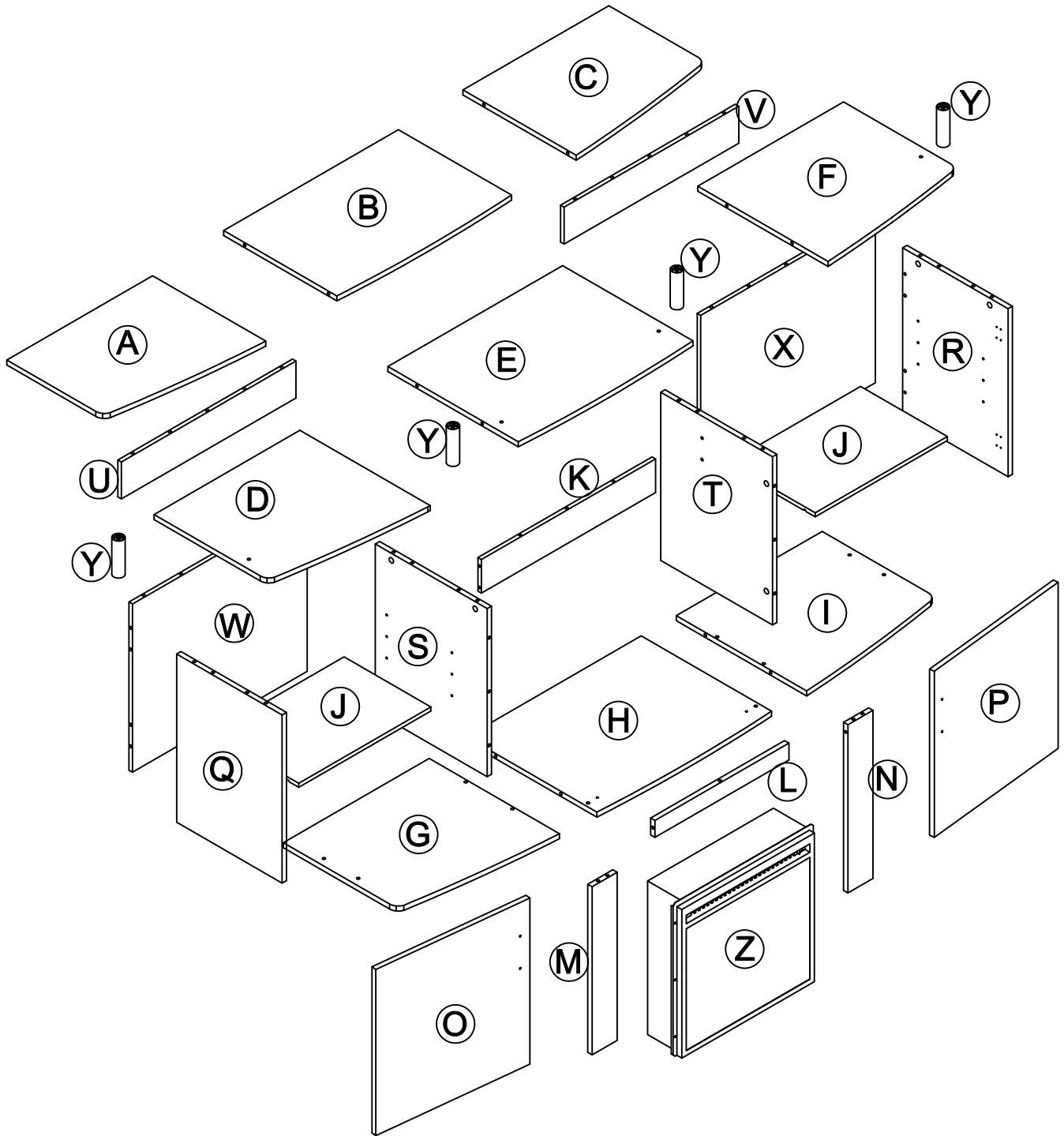

Part List

Actual Size

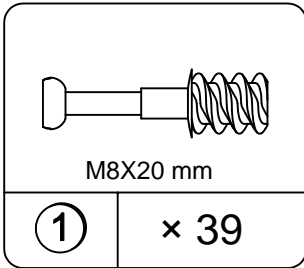

Cam bolt
TKX1191

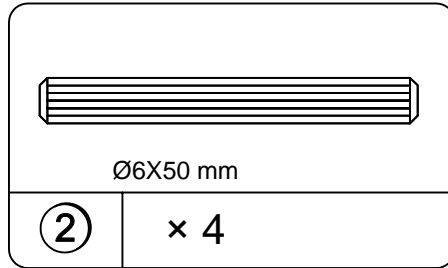

Wood dowel
TKX1202

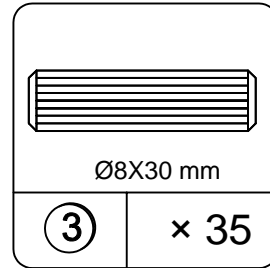

Wood dowel
TKX1005

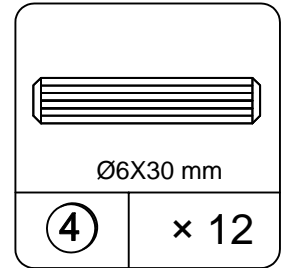

Wood dowel
TKX1006

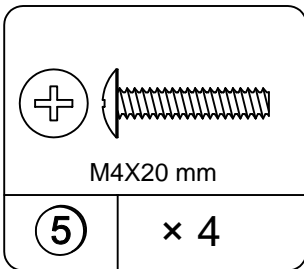

Bolt
TKX1192

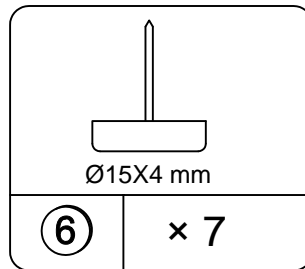

Tack glide
TKX1179

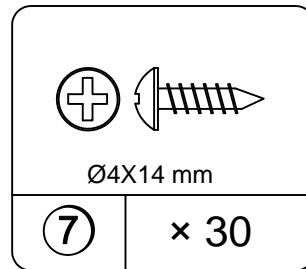

Screw
TKX1038

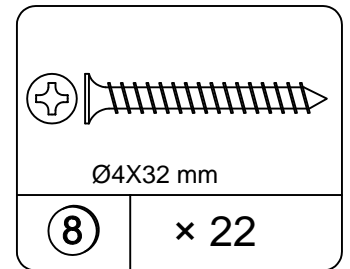

Screw
TKX1230

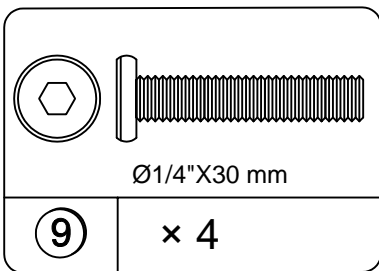

Bolt
TKX1229

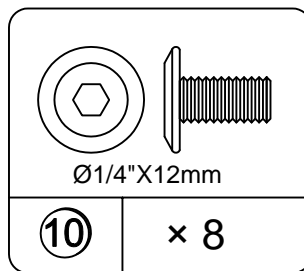

Bolt
TKX1204

Part List

Not Actual Size

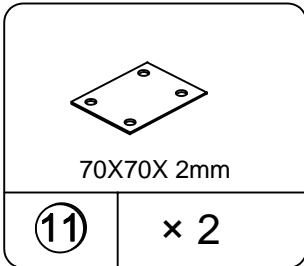

Metal plate
TKX1225

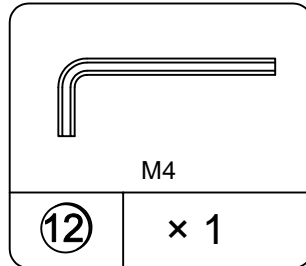

Hex key
TKX1140

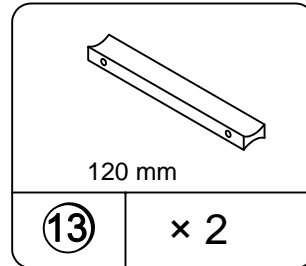

Handle
TKX1227

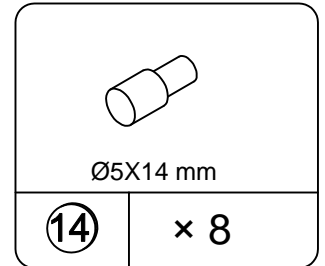

Support pin
TKX1254

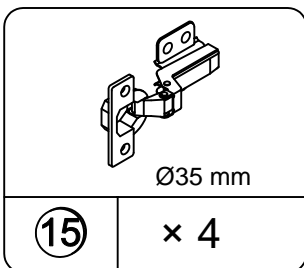

Euro hinge
TKX1020

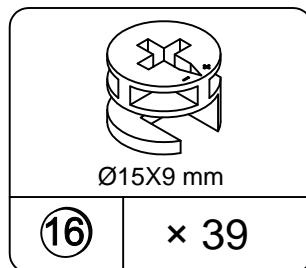

Cam lock
TKX1011

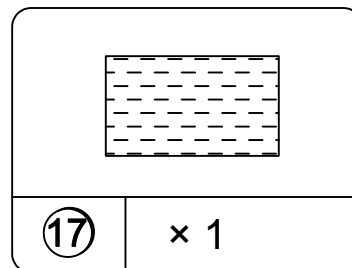

Warning label
TKX3010

STEP 1

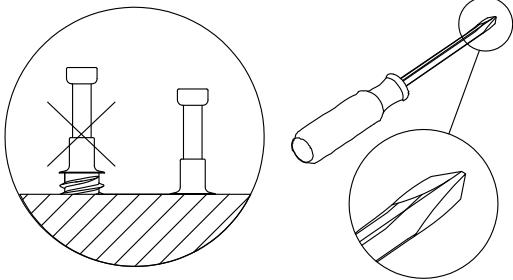
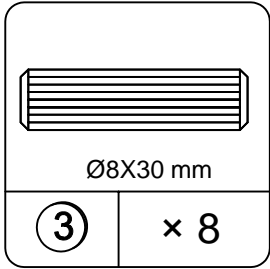
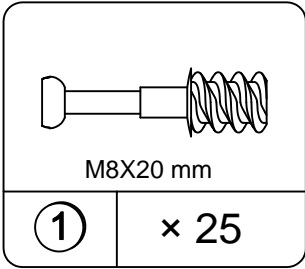

1.1 Attach (1) to (A), (B), (C), (D), (E) & (F) as illustrated.
 1.2 Insert (3) to (B) & (E) as illustrated.

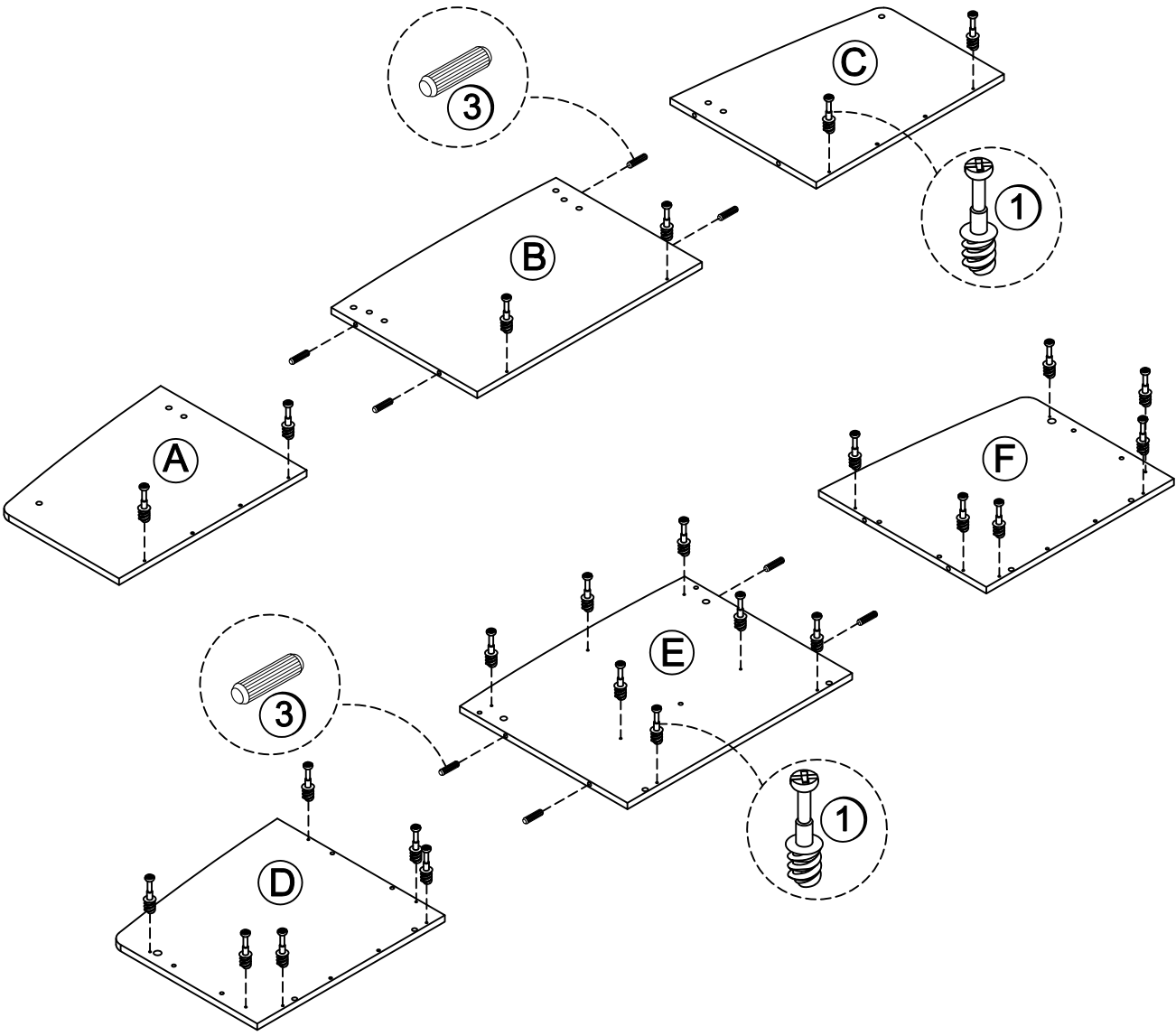

STEP 2

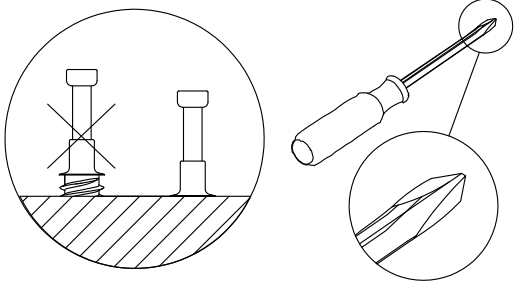
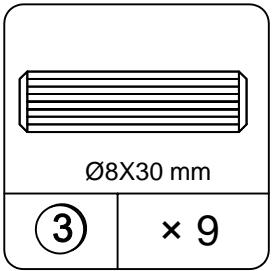
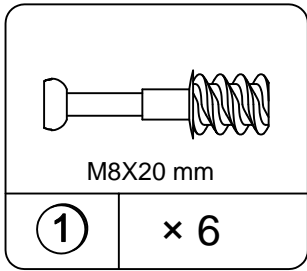

2.1 Attach (1) to (M) & (N) as illustrated.
 2.2 Insert (3) to (H), (K), (M) & (N) as illustrated.

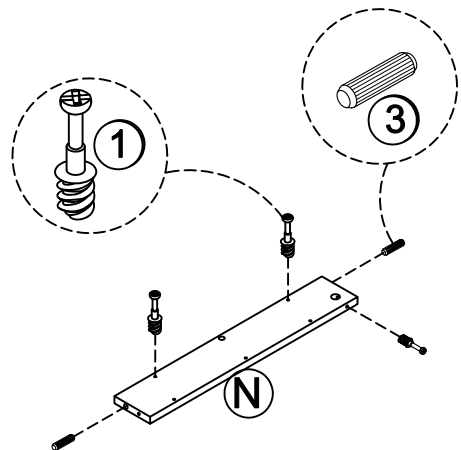
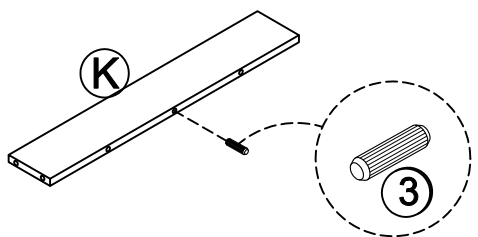
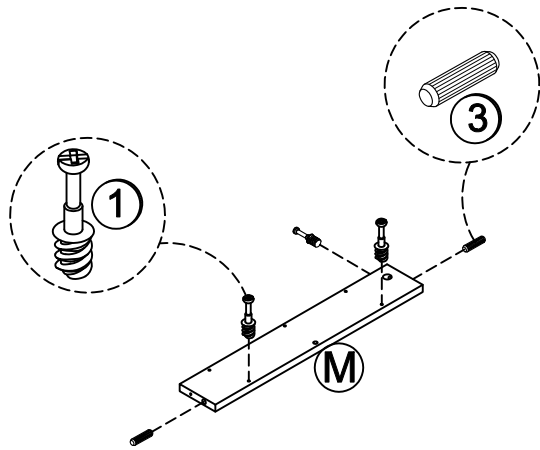
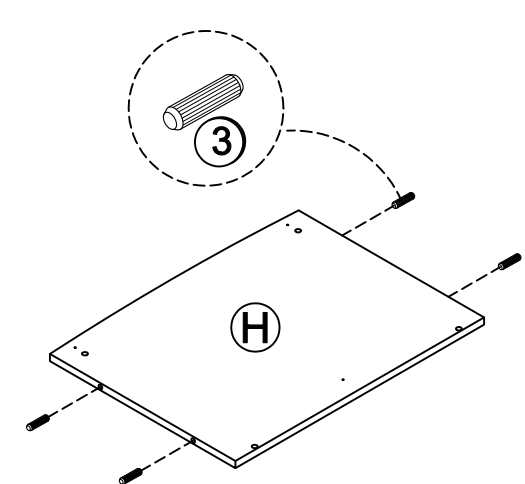

STEP 3

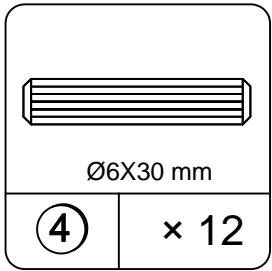

3.1 Insert (4) to (U), (V), (W) & (X) as illustrated.

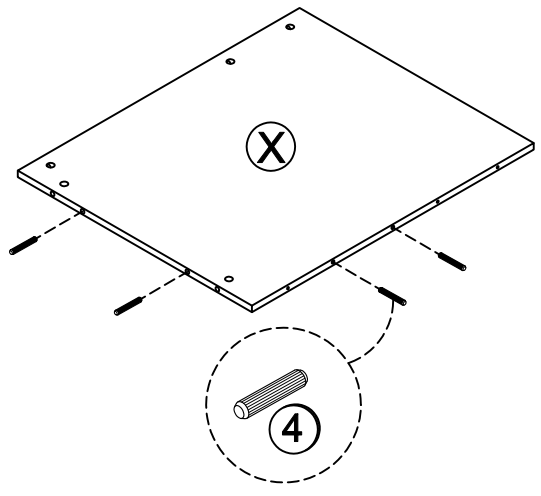
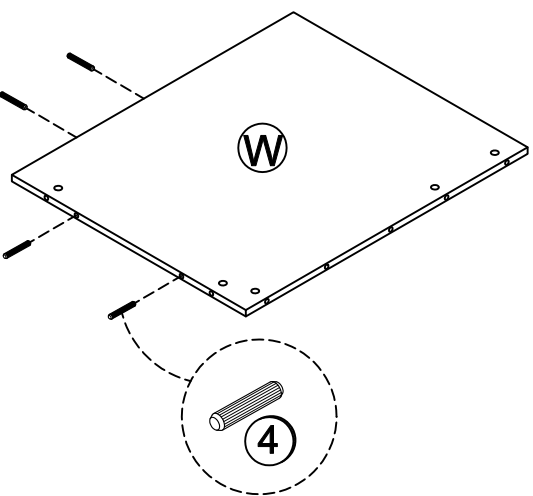
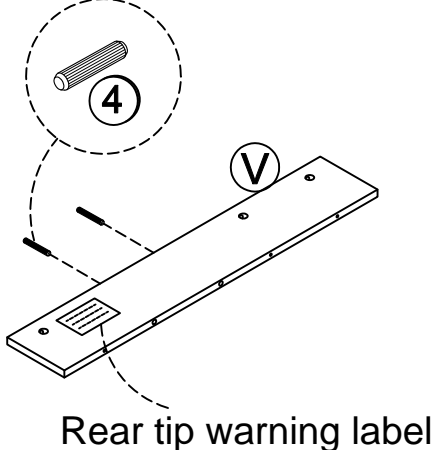
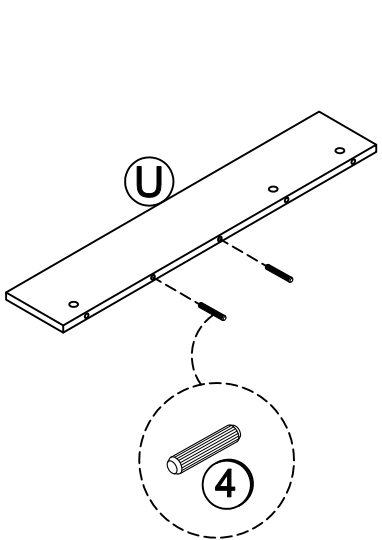

STEP 4

 M8X20 mm		 Ø8X30 mm		 Ø4X14 mm		 Ø35 mm	
①	× 8	③	× 18	⑦	× 16	⑮	× 4

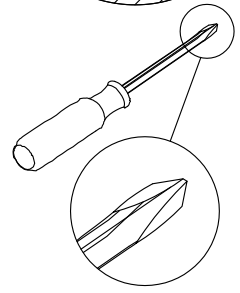
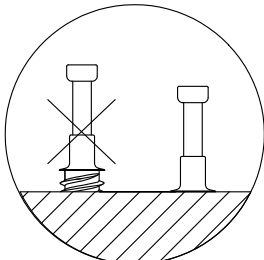

- 4.1 Attach (1) to (Q), (R), (T) & (S) as illustrated.
- 4.2 Insert (3) to (Q), (R), (T) & (S) as illustrated.
- 4.3 Attach (15) to (Q) & (R) with (7) as illustrated.

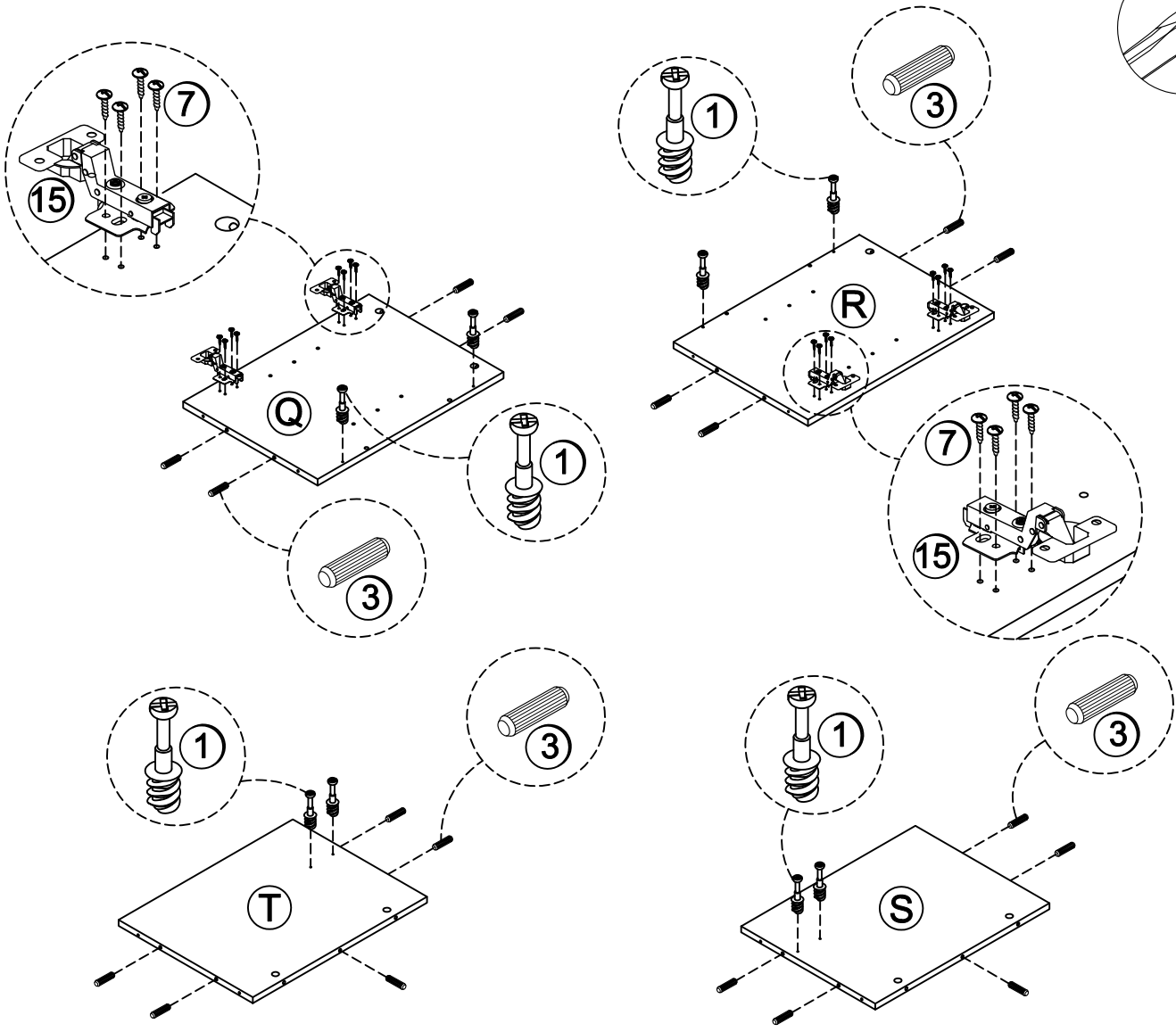

STEP 5

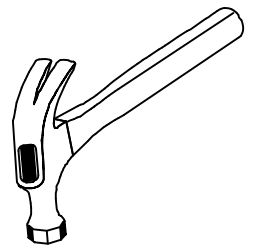
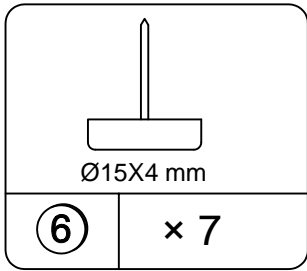

- 5.1 Connect (E), (D) & (F) as illustrated.
- 5.2 Attach (6) to (G), (H) & (I) as illustrated.
- 5.3 Connect (H) to (G) & (I) as illustrated.

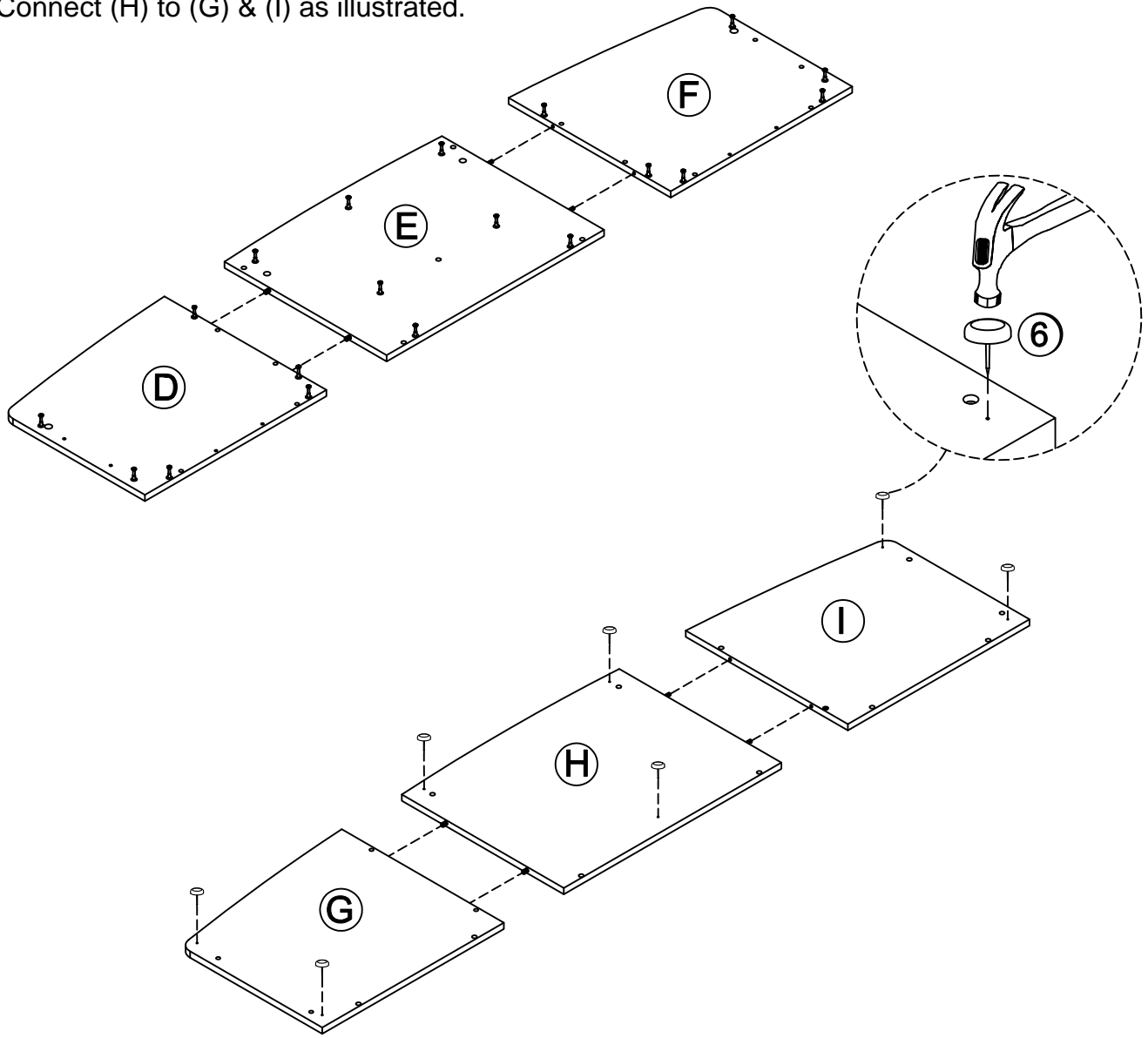

STEP 6

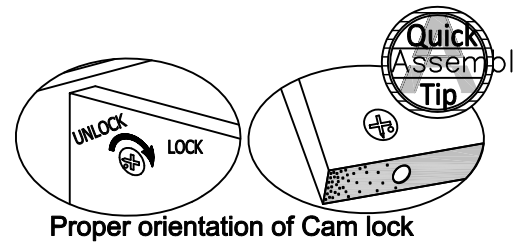
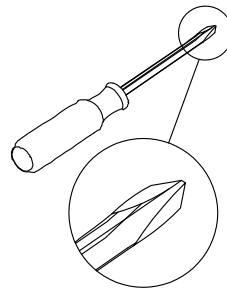
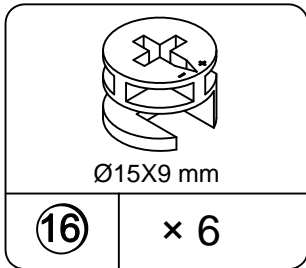

- 6.1 Connect (B) to (A) & (C) as illustrated.
- 6.2 Attach (U) to (A) & (B) with (16) as illustrated.
- 6.3 Attach (V) to (B) & (C) with (16) as illustrated.

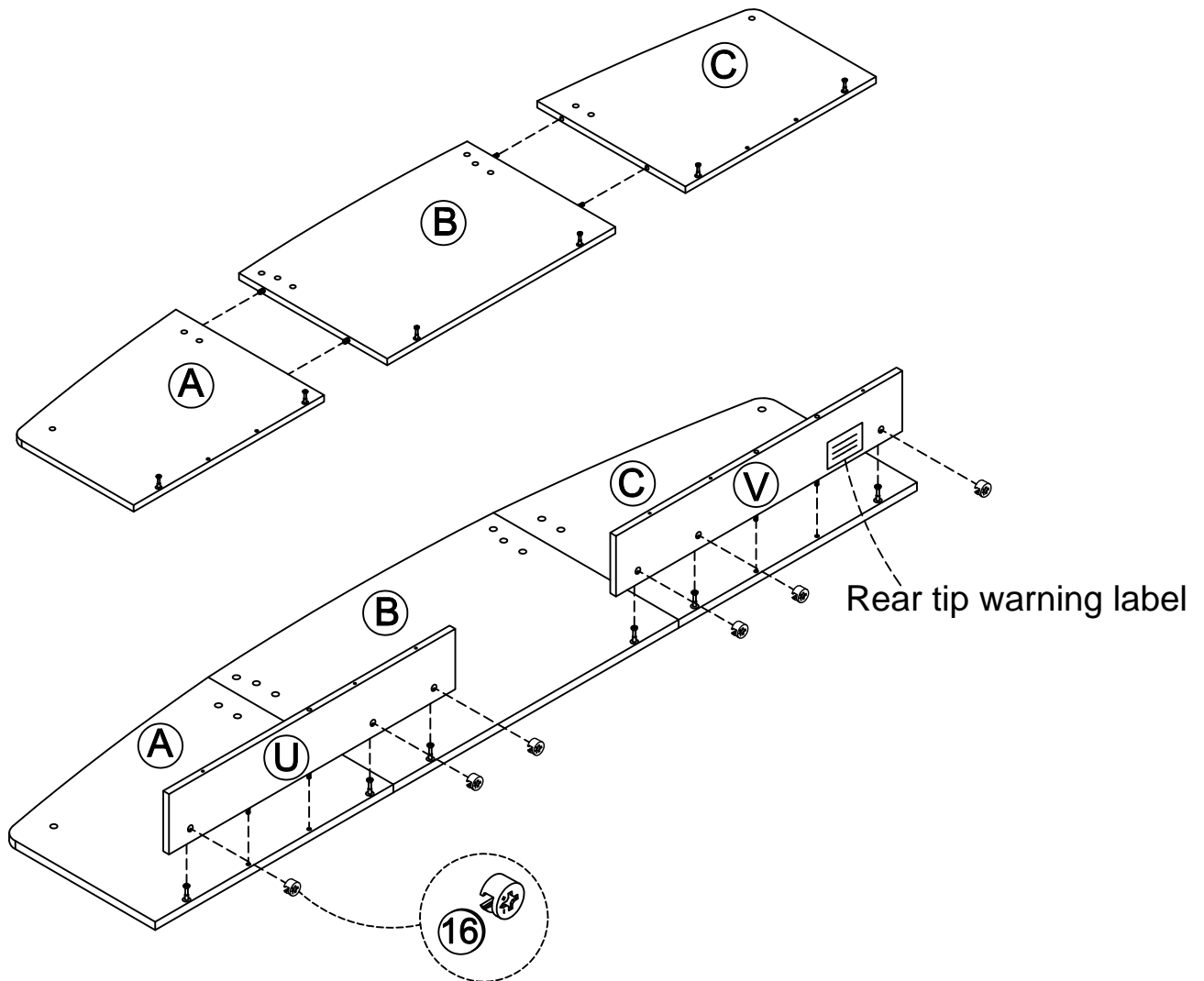

STEP 7

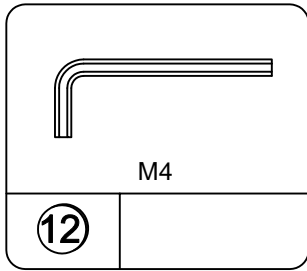
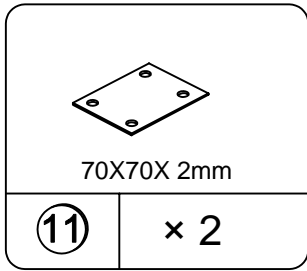
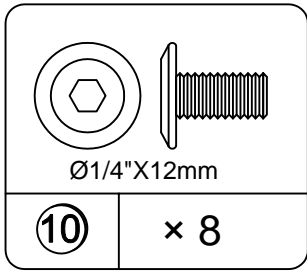

7.1 Attach (11) to (A), (B) & (C), with (10) as illustrated.
 7.2 Attach (Y) to (A), (B) & (C) as illustrated.

CAUTION: Do not over-tighten support tube to avoid damage the board.

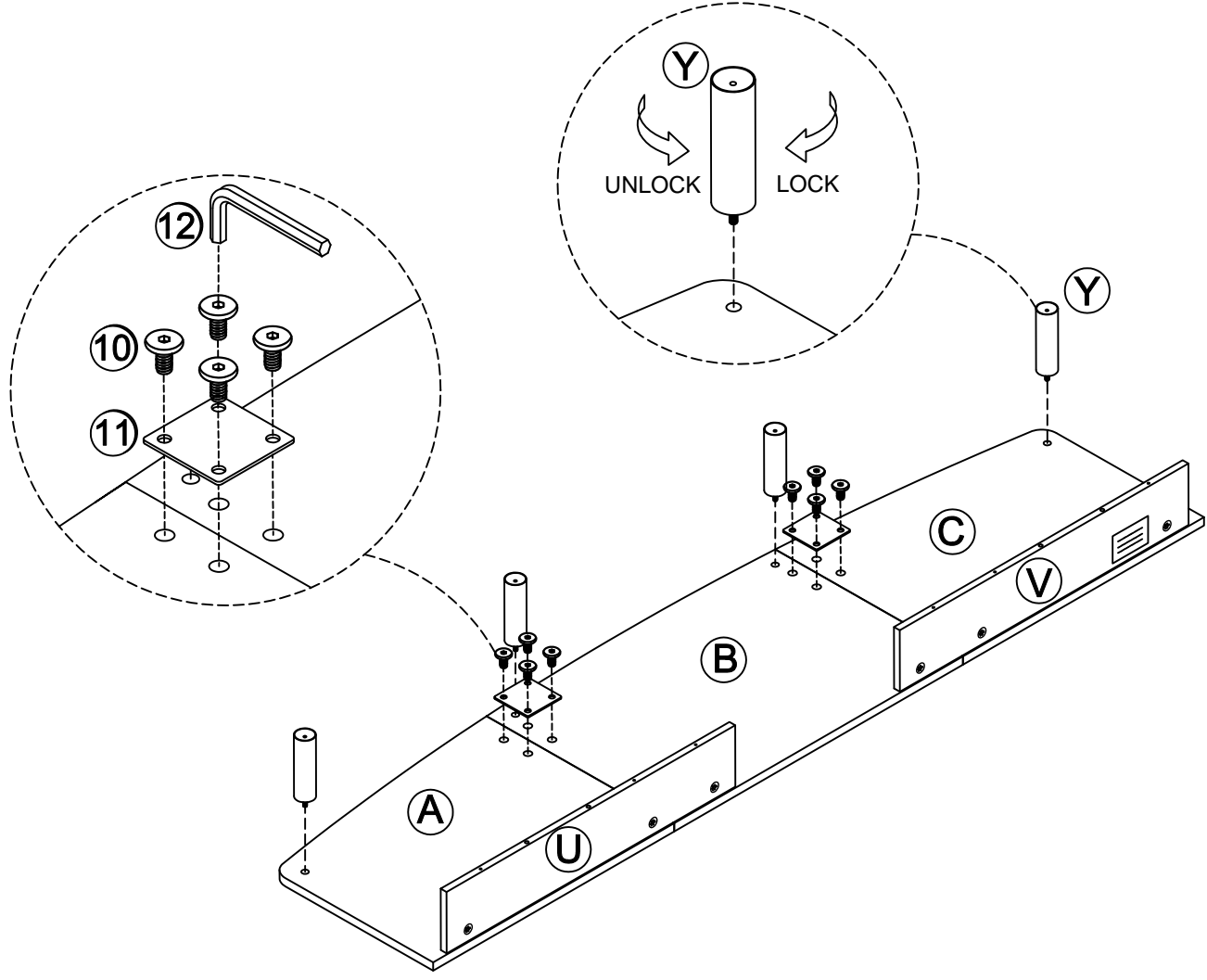

STEP 8

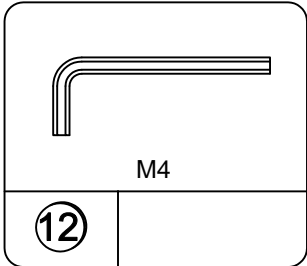
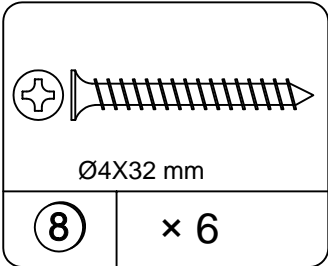
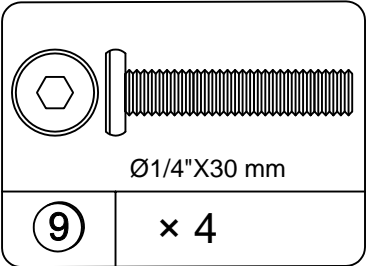
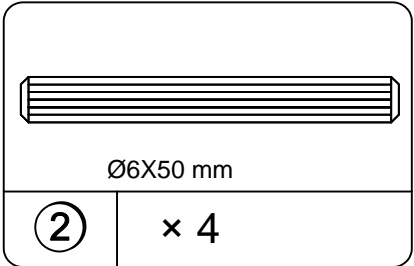

8.1 Insert (2) to (U) & (V) as illustrated.
 8.2 Attach (D), (E) & (F) to sample at previous step with (8) & (9) as illustrated.

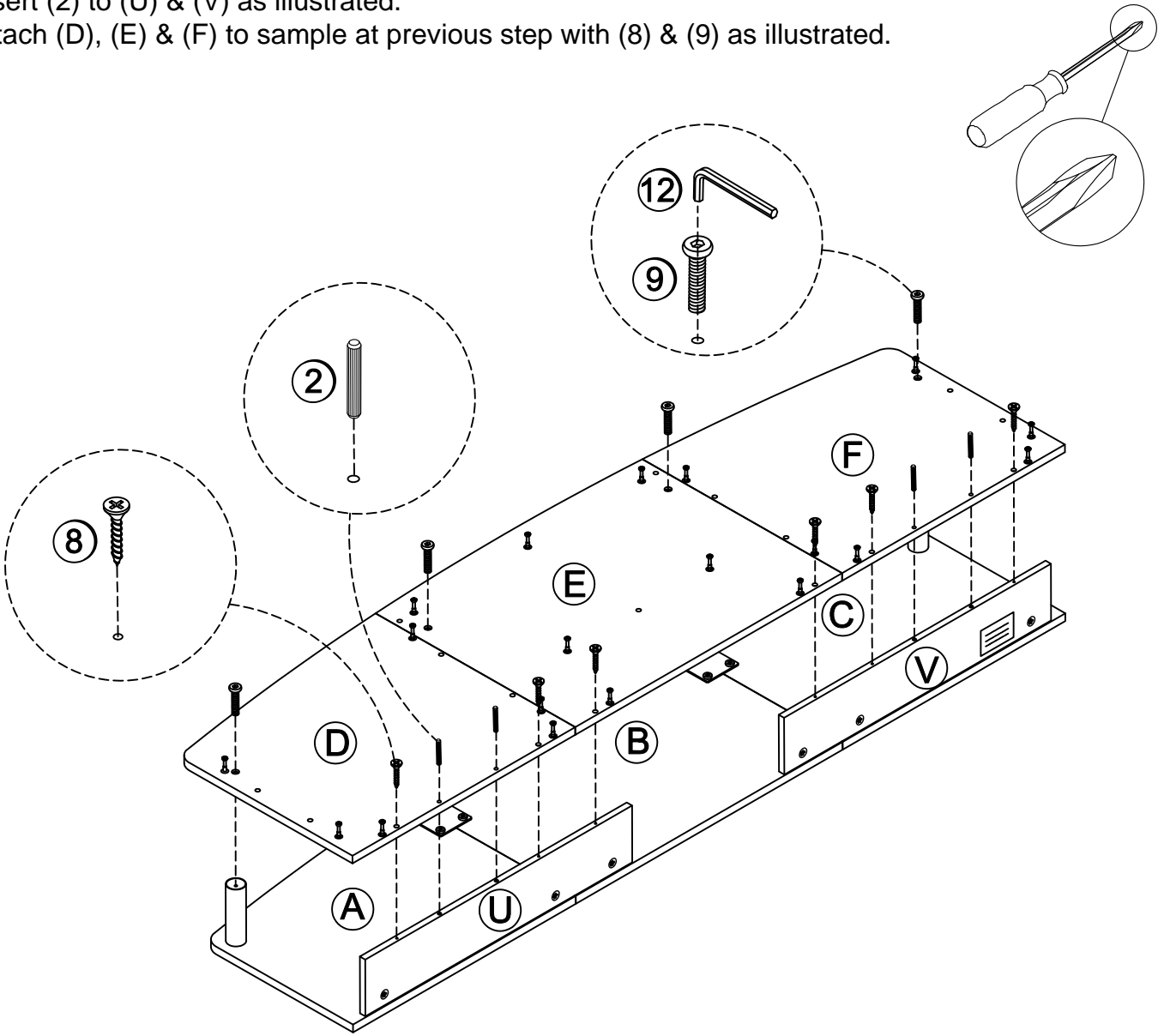

STEP 9

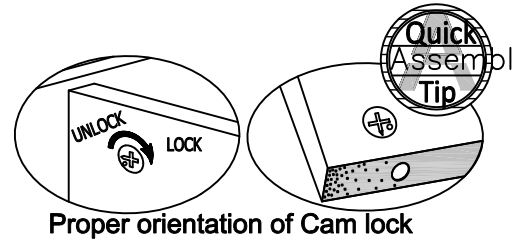
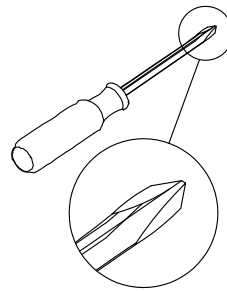
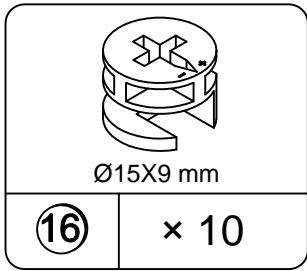

- 9.1 Attach (K) to (T) & (S) with (16) as illustrated.
- 9.2 Attach (L) to (M) & (N) with (16) as illustrated.
- 9.3 Attach (K)-(S)-(T) to (L)-(M)-(N) with (16) as illustrated.

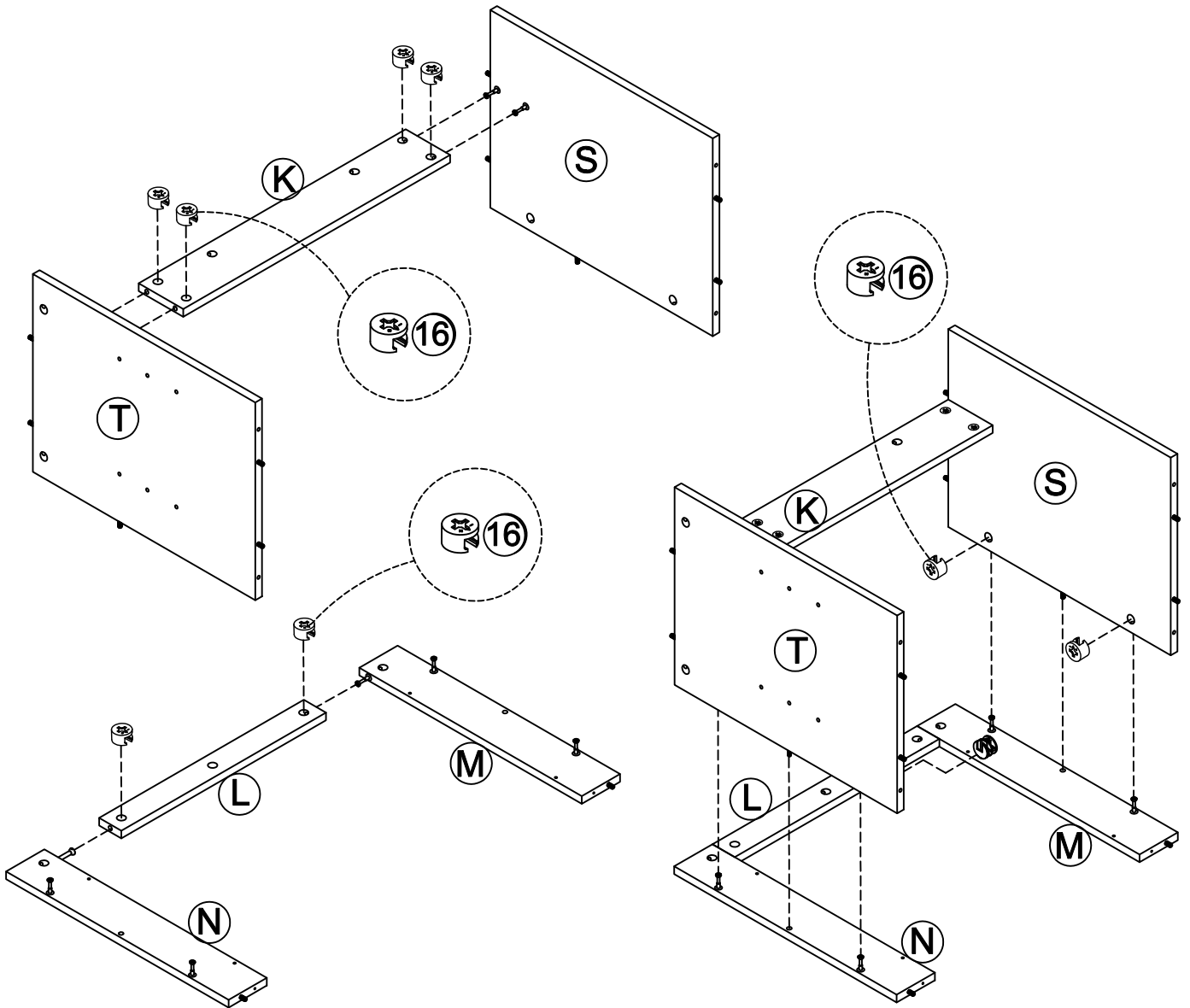

STEP 10

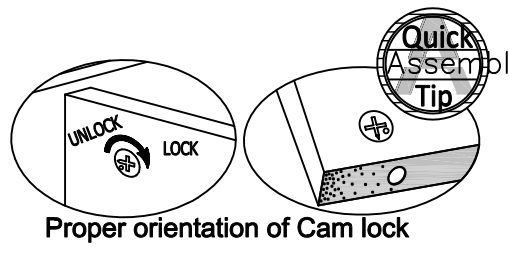
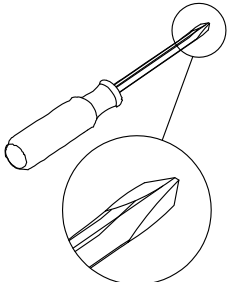
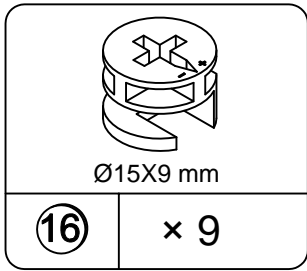

10.1 Attach sample at step (9) to (D), (E) & (F) with (16) as illustrated.

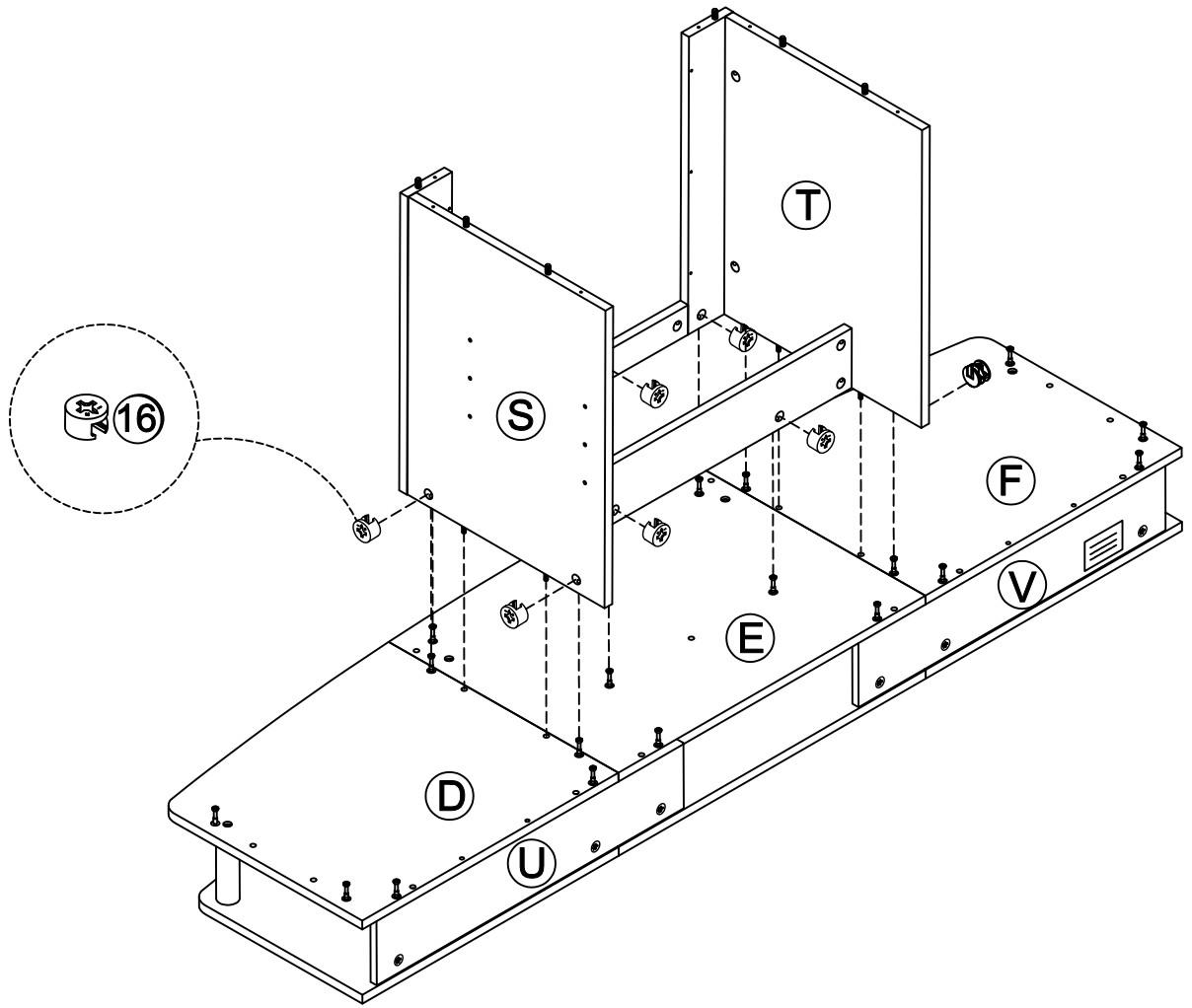

STEP 11

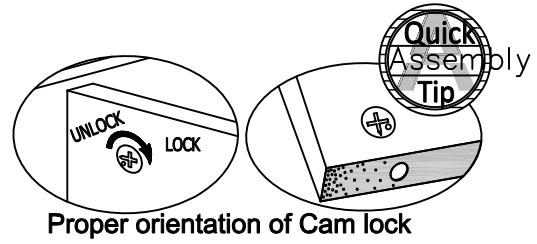
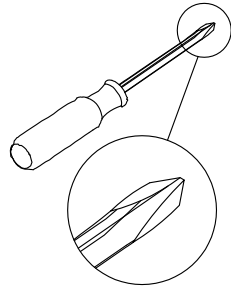
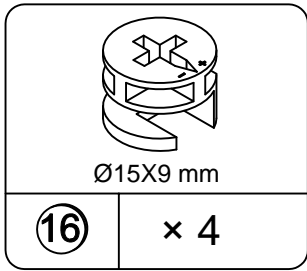

11.1 Attach (W) to (Q); (X) to (R) with (16) as illustrated.

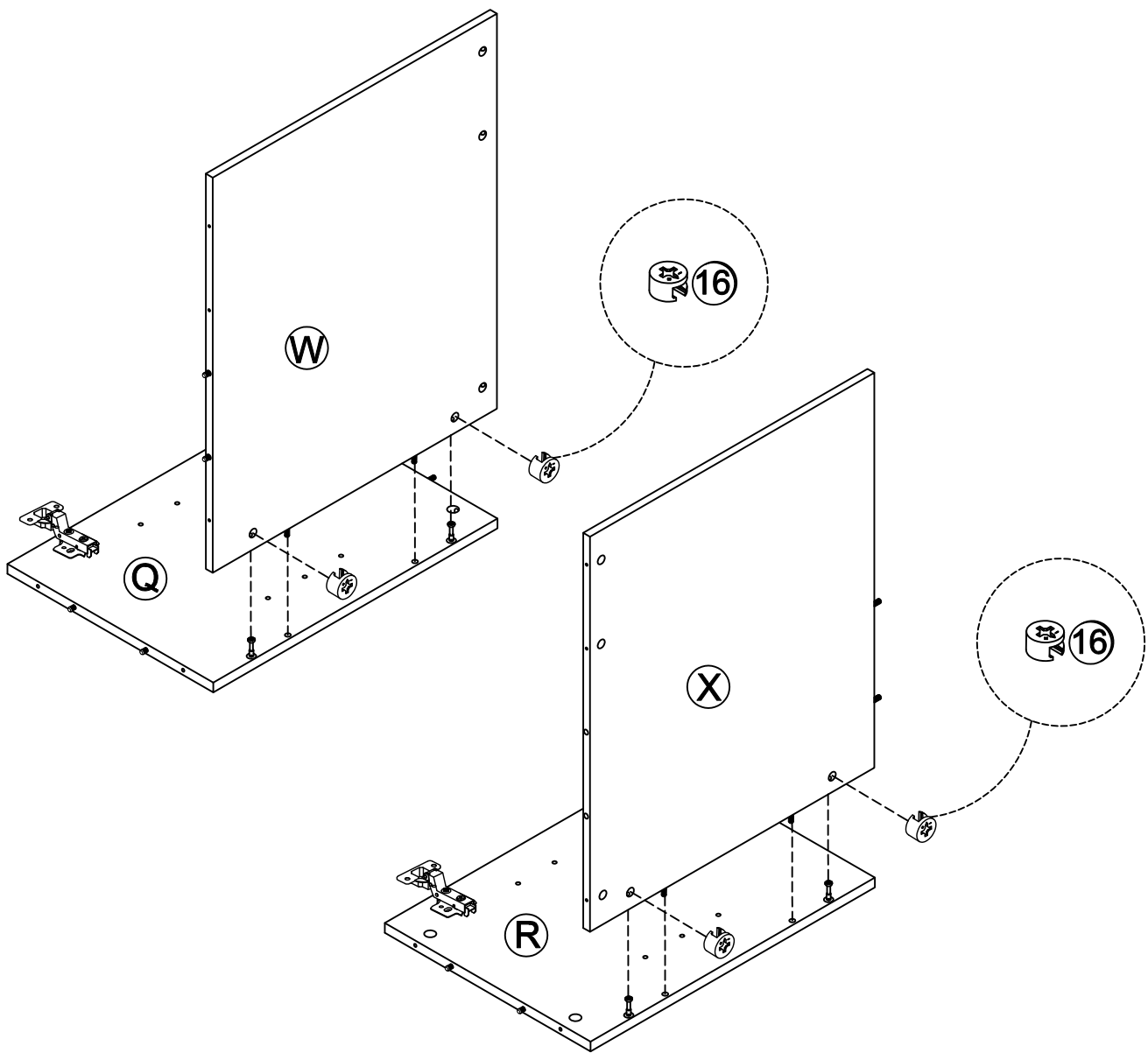

STEP 12

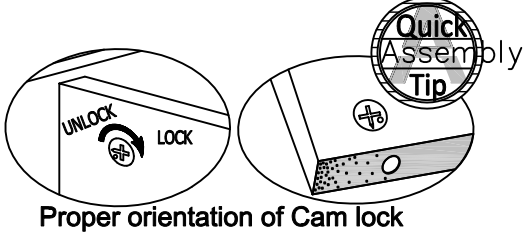
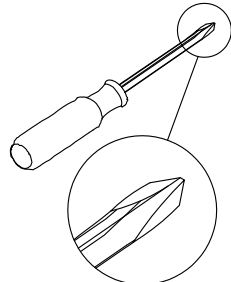
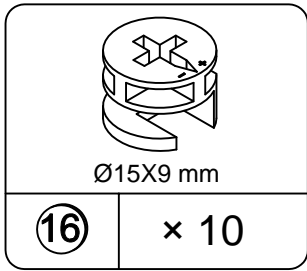

12.1 Attach (Q)-(W) and (R)-(X) to sample at step 10 with (16) as illustrated.

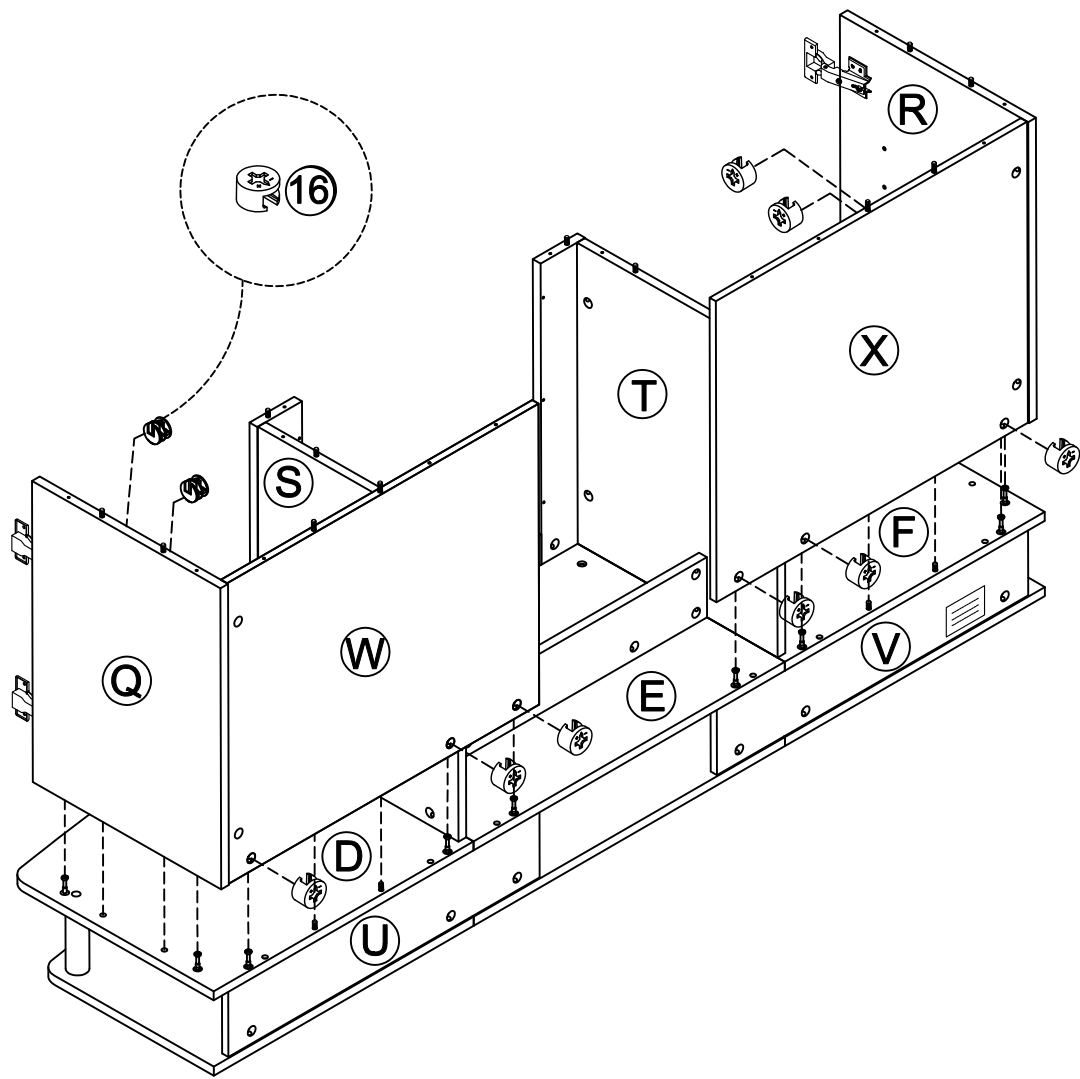

STEP 13

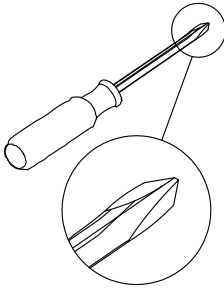
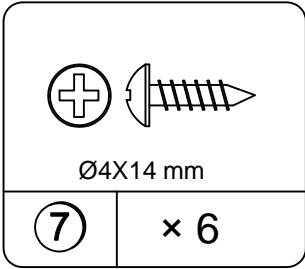

13.1 Attach (Z) to frame with (7) as illustrated.

Note: Please check and tighten all screws in this step

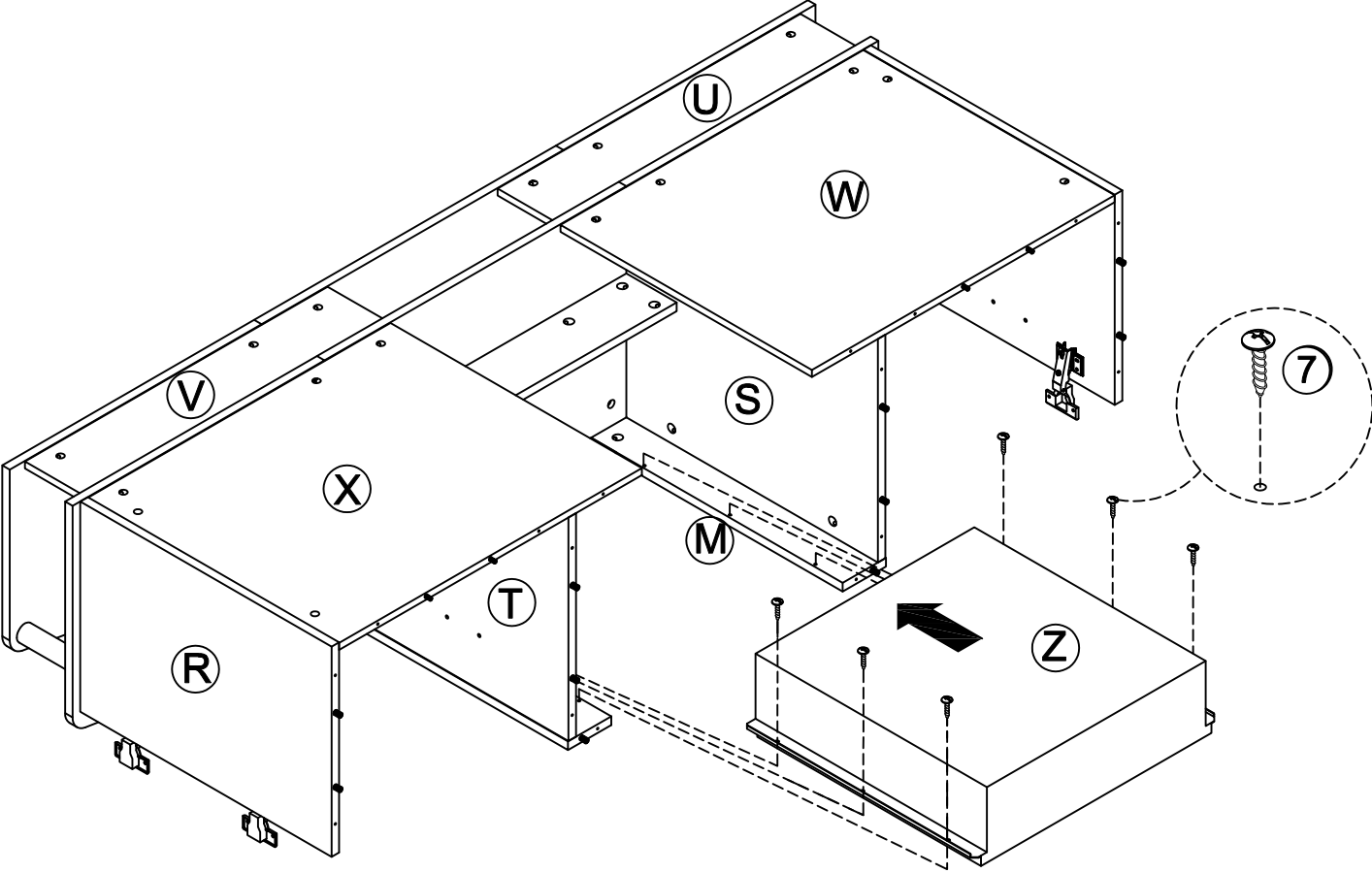

STEP 14

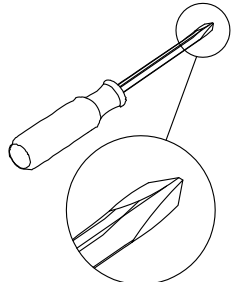
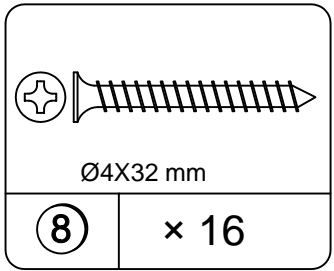

14.1 Attach (G), (H) & (I) to sample from previous step with (8) as illustrated.

Note: Please check and tighten all screws in this step

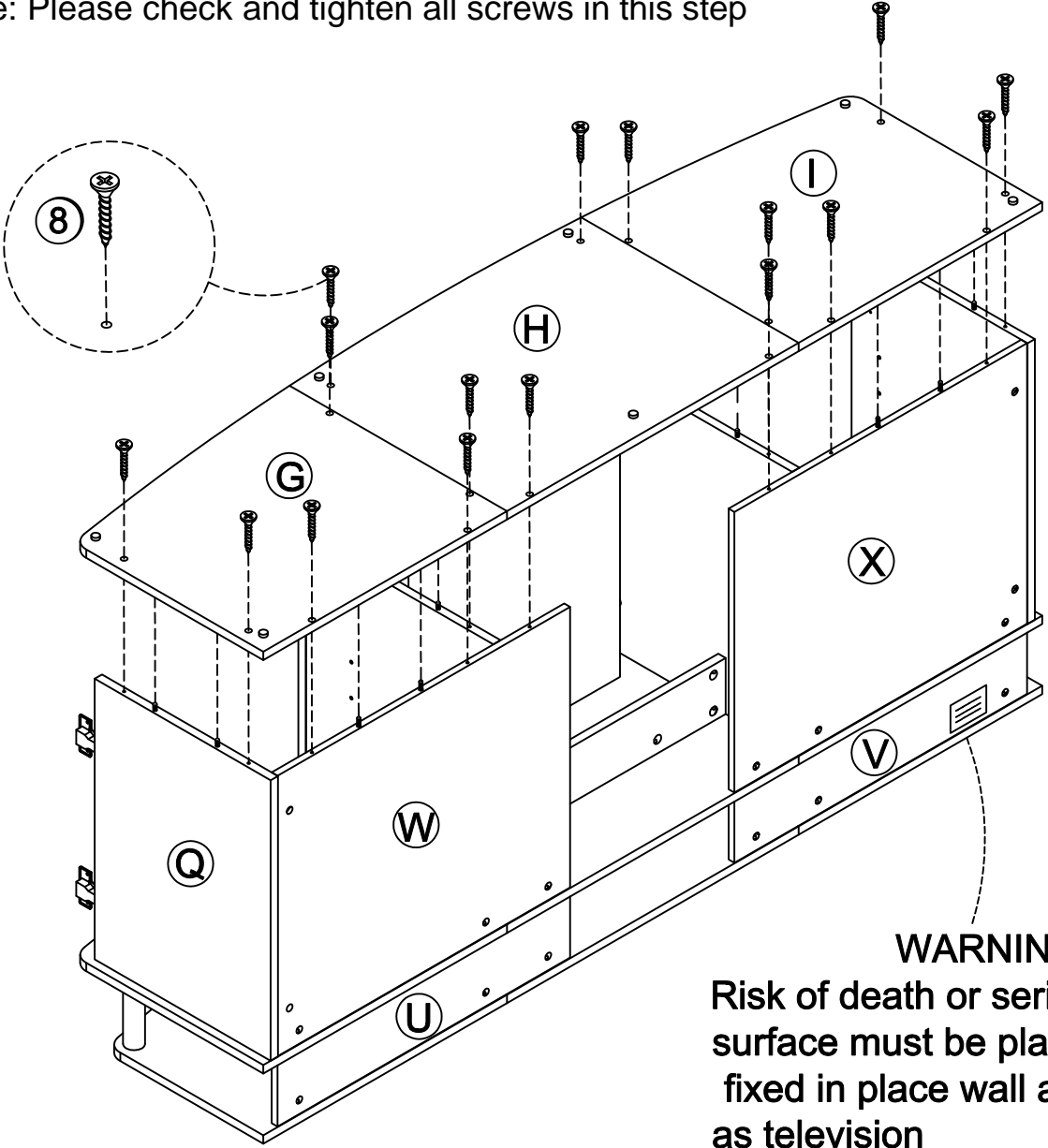

WARNING
Risk of death or serious injury. This surface must be placed against a fixed in place wall at least as tall as television

STEP 15

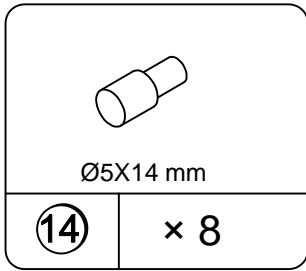

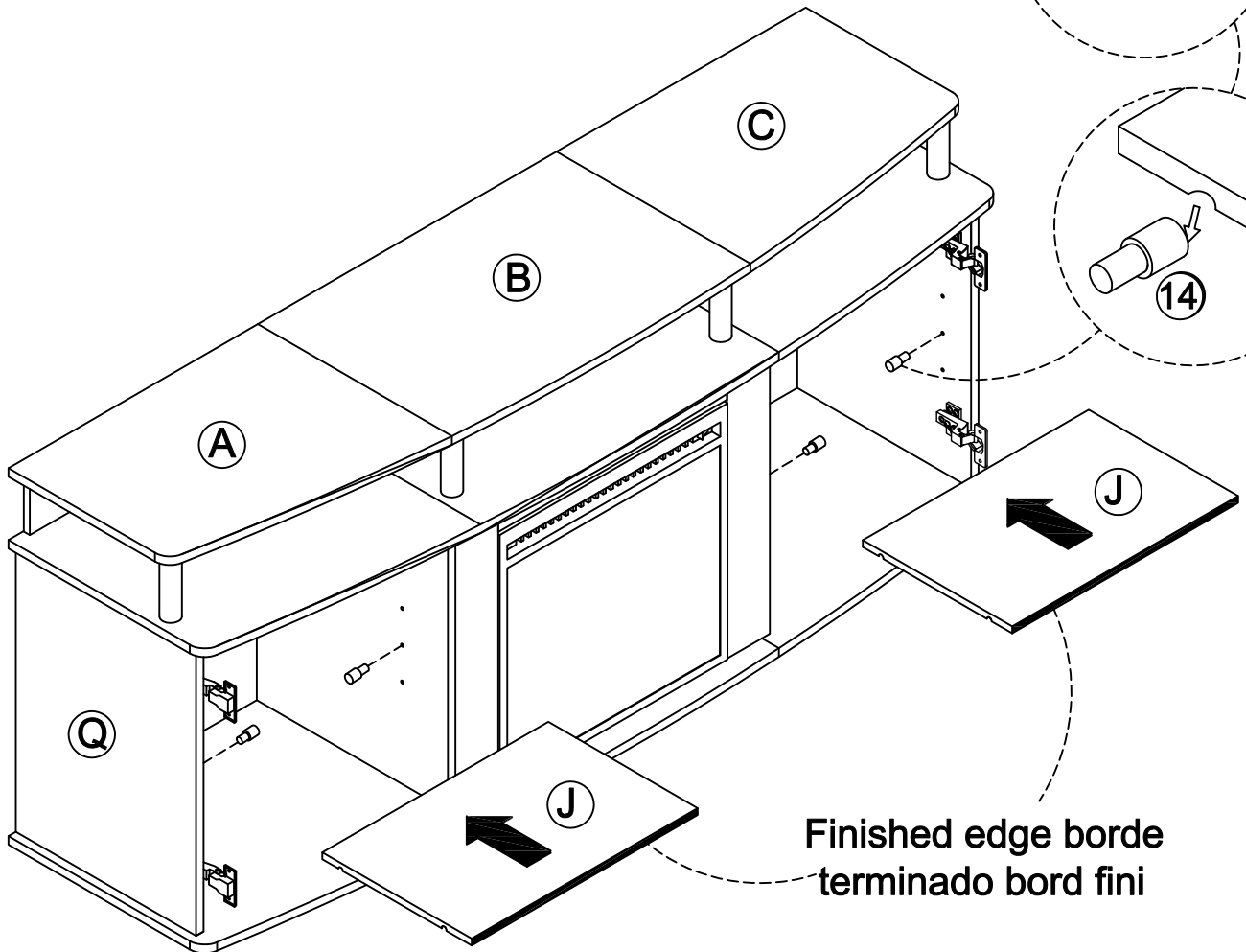
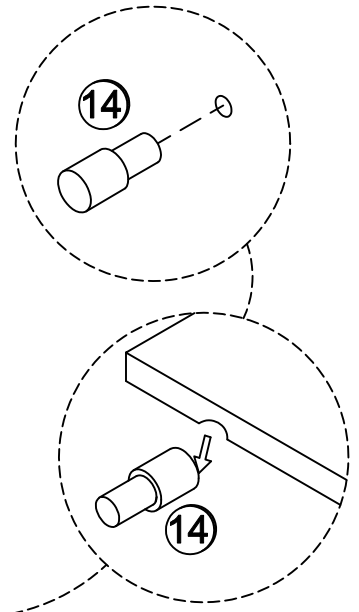
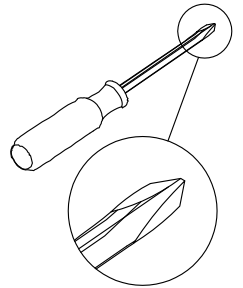

- 15.1 Insert (14) to frame as illustrated.
- 15.2 Put (J) on shelf pin (14) as illustrated.

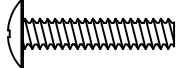

STEP 16

 	
M4X20 mm	
5	× 4

 	
Ø4X14 mm	
7	× 8

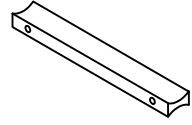
	
120 mm	
13	× 2

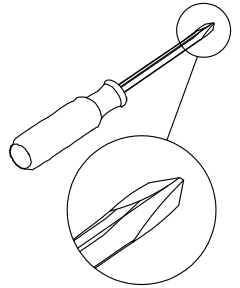

16.1 Attach (O), (P) to sample from previous step with (7) as illustrated.
 16.2 Attach (13) to (O), (P) with (5) as illustrated.

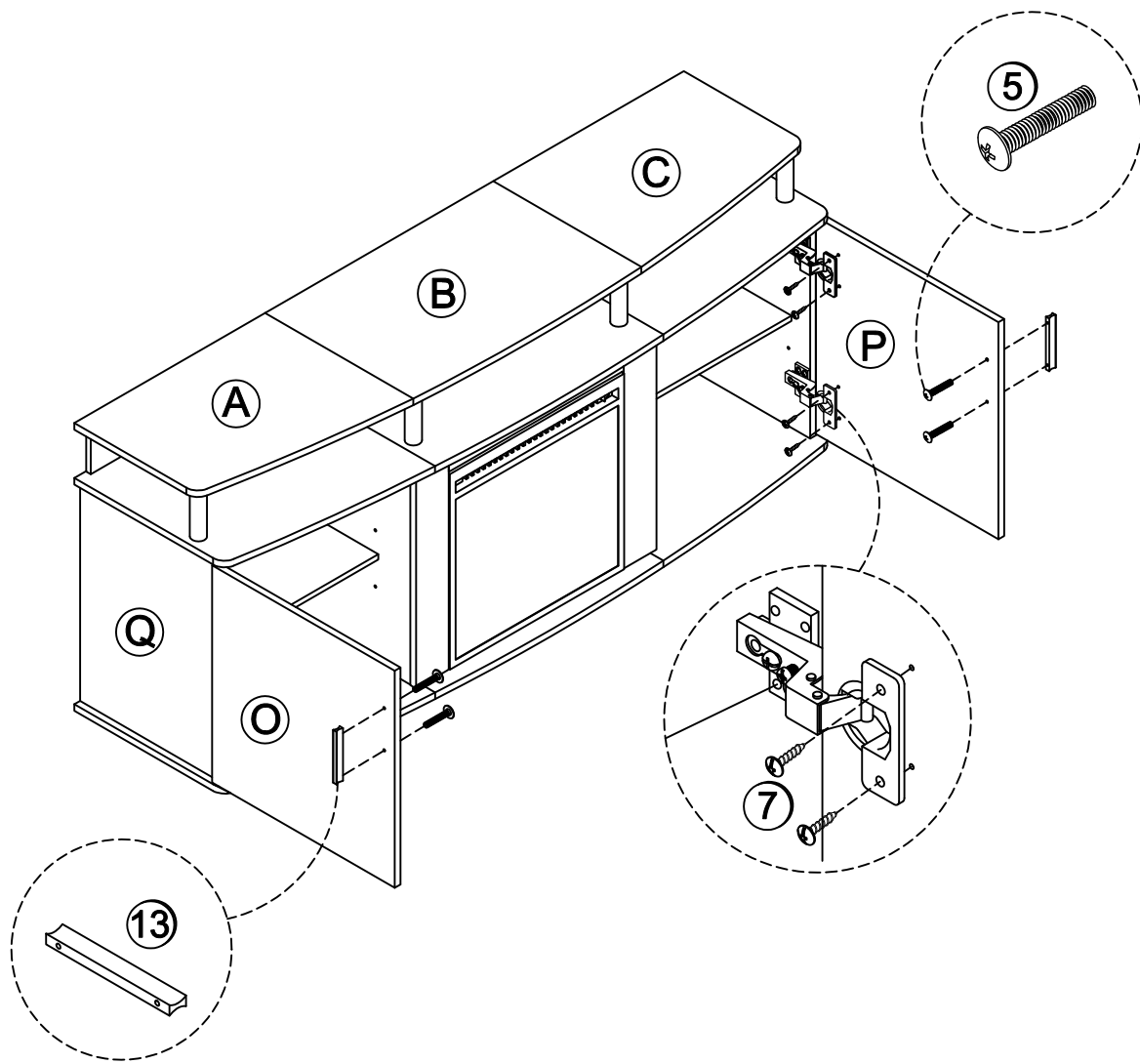

STEP 17

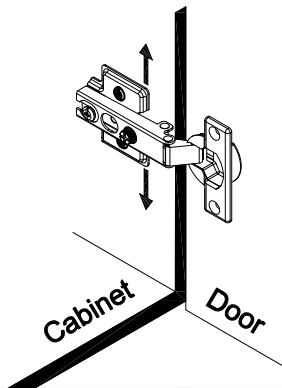
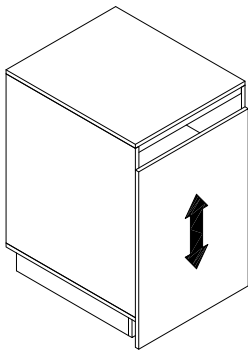
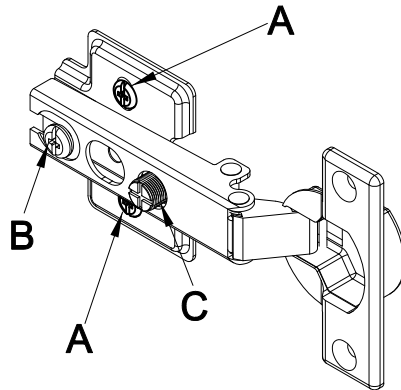

To adjust the vertical height.

Loosen the four screws "A" on both hinges. Two of them are usually in slotted holes which allows you to adjust up or down by a few mm. Then tighten back up.

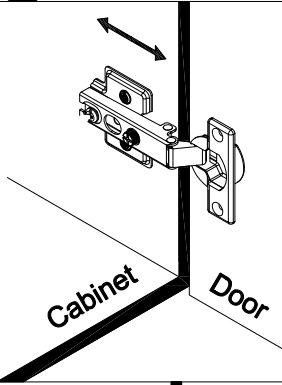
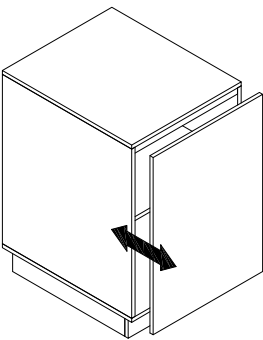

To adjust depth.

Loosen screw "B" and adjust door, if the door can not be adjusted, please loosen screw "C", then try again. Tighten screw "B" and "C".

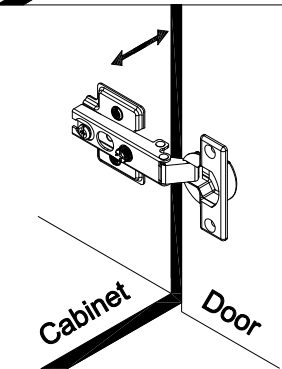
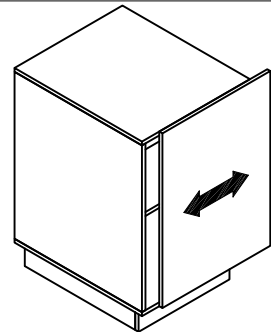

To adjust side ways.

Turning the screw "C" on BOTH hinges on each door.

WARNING

If the information in the fireplace operating manual is not followed, an electric shock or fire may result in property damage, personal injury, or loss of life.

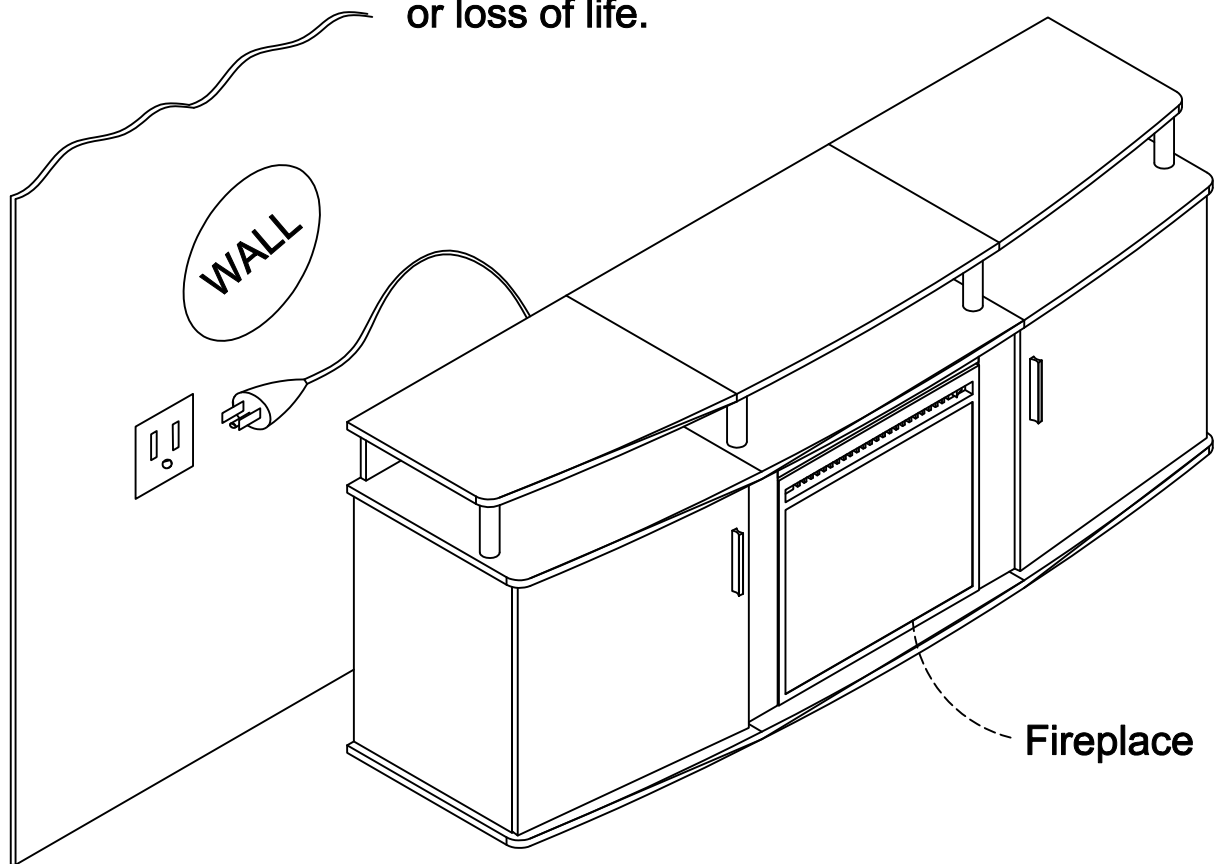

WARNING

Risk of death or serious injury.
This unit must be placed against a fixed in place wall at least as tall as television.

Maximum Loads

This unit has been designed to support the maximum loads shown. Exceeding these load limits could cause sagging, instability, product collapse, and/or serious injury.

Warning: Please apply the TV warning label to your unit so you'll always have the model's weight and TV size limits.

Maximum TV size: 70" flat screen, 120 Lbs/54.5 kgs.

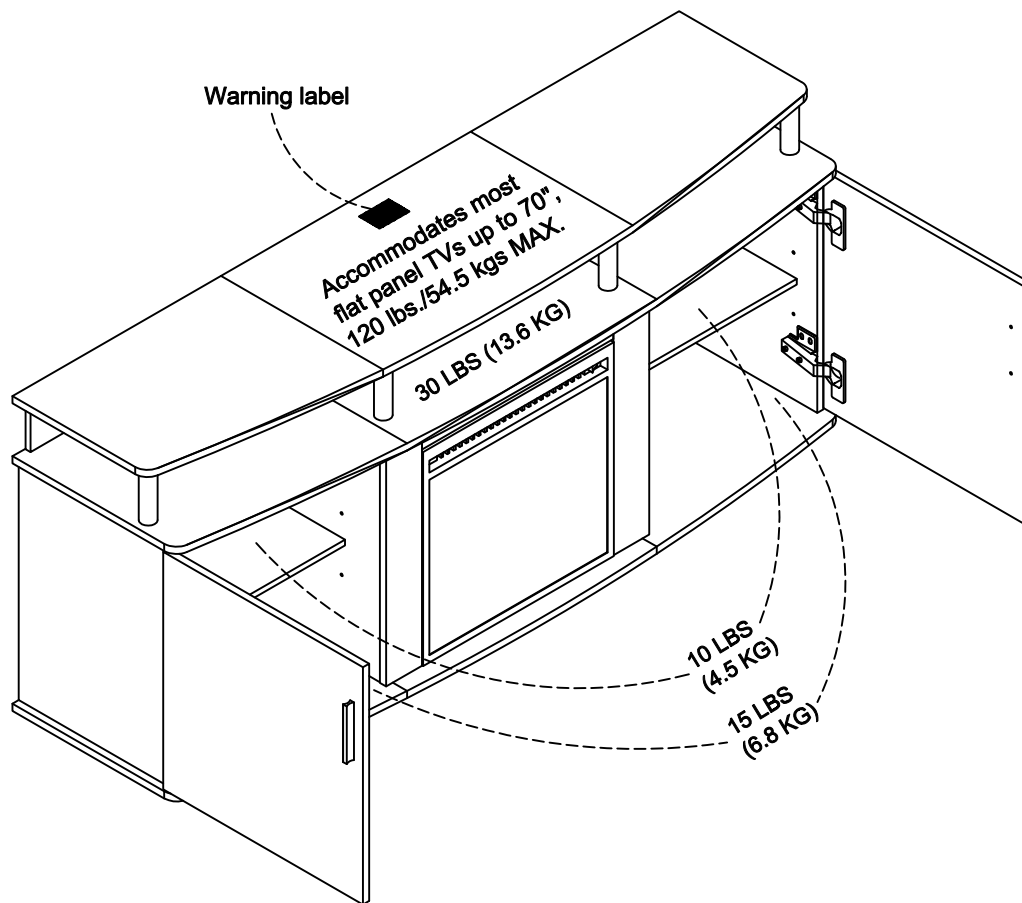

Certificate of Conformity

1. This certificate applies to the Dorel Home Furnishings, Inc. product identified by this instruction manual.
2. This certificate applies to compliance of this product with the CPSC Ban on Lead-Containing Paint (16 CFR 1303).
3. This product is distributed by: Dorel Home Furnishings, Inc.
410 East First Street South
Wright City, MO 63390
636-745-3351
4. Site of Manufacture: Svay Rieng, Cambodia
5. See front page of instruction manual for date of manufacture.

Register your product to receive the following:



- * New trend details - sneak peek on what's new
- * Surveys - have a voice within our community
- * Exclusive deals and discount codes
- * Quick and easy replacement part service

To register your product, visit ameriwoodhome.com

Star Rating



Visit your local retailer's website, rate your purchased product and leave us some feedback!

We would like to extend a big "Thank You" to all of our customers for taking the time to assemble this Ameriwood Home product, and to give us your valuable feedback.

*Thank
You!*

Cubierta Delantera

Este libro de instrucciones contiene información **IMPORTANTE** de seguridad. Por favor lea y manténgalo para referencia en el futuro.

No Regrese este producto! Comuníquese con nuestro amigoso equipo de servicio al cliente para obtener ayuda.

Llámenos al: 1-800-489-3351 (Gratis) Lunes - Viernes 9am - 5pm CST

Visitar: www.ameriwoodhome.com

PRECAUCION

Este mueble puede volcarse y causar graves heridas y/o muerte.

Anclar el mueble a un poste de madera en la pared (si esto se requiere).

No Permita que los niños monten el mueble.

Mantenga los artículos más pesados en los cajones de abajo.

Consejos Útiles (página 2)

- Abra su artículo en el área donde usted planea utilizarlo para evitar levantar y moverlo menos
- Identificar, ordenar y contar las piezas antes de intentar ensamblar
- Las clavijas de compresión se golpean con un martillo
- Las diapositivas están marcadas con una R (derecha) y L (izquierda) para la colocación correcta
- Asegúrese de que siempre este el punto localizado en la parte superior de bloqueador de leva este volteado hacia borde exterior
- Utilizar todos los clavos para el panel de atrás y distribuirlos por igual
- El panel de atrás debe utilizarse para asegurarse de que la unidad quede fija y firme
- No use químicas fuertes ni limpiadores abrasivos en este artículo
- Nunca empuje, tire ni arrastre los muebles

Antes de Que Empieces (página 3)

- Lea cuidadosamente cada paso y siga el orden correcto

- Separar y contar todas sus piezas y hardware

- Dése suficiente espacio para el proceso de ensamble

- Tenga las siguientes herramientas: destornillador de cabeza plana, #2 cabeza Phillips

Destornillador y martillo

- Precaución: Si usa un taladro electrónico o un destornillador eléctrico para atornillar, por favor asegúrese que deje de atornillar cuando el tornillo este apretado. Fallar hacer esto puede causar barrer el tornillo.

Sistema de fijar el bloqueo de leva (página 3)

Este sistema de fijar el bloqueo de leva sera usado en todo el proceso ensamble.

Identificación de los Paneles (Página 4-7)

Este no es el tamaño real

- (A) ARRIBA IZQUIERDA
- (B) PARTE MEDIA
- (C) ARRIBA DERECHA
- (D) ESTANTE IZQUIERDO
- (E) ESTANTE MEDIO
- (F) ESTANTE DERECHO
- (G) INFERIOR IZQUIERDA
- (H) PARTE INFERIOR MEDIA
- (I) INFERIOR DERECHA
- (J) ESTANTE AJUSTABLE
- (K) PANEL DE SOPORTE
- (L) DELANTAL SUPERIOR
- (M) DELANTAL IZQUIERDO
- (N) DELANTAL DERECHO
- (O) PUERTA IZQUIERDA
- (P) PUERTA DERECHA
- (Q) PANEL LATERAL IZQUIERDO
- (R) PANEL LATERAL DERECHO
- (S) PARICIÓN IZQUIERDA
- (T) PARTICIÓN DERECHA
- (U) PANEL TRASERO SUPERIOR IZQUIERDO
- (V) PANEL TRASERO SUPERIOR DERECHO
- (W) PANEL TRASERO INFERIOR IZQUIERDO
- (X) PANEL TRASERO INFERIOR DERECHO
- (Y) TUBO DE SOPORTE
- (Z) INSERTO PARA CHIMENEA

Lista de Piezas (Página 8)

Tamaño real

- (1) Perno de leva
- (2) Pasador de madera
- (3) Pasador de madera
- (4) Pasador de madera
- (5) Perno
- (6) Planeo de virada
- (7) Tornillo
- (8) Tornillo
- (9) Perno
- (10) Perno

Lista de Piezas (Página 9)

Este no es el tamaño real

- (11) Placa de metal
- (12) Llave hexagonal
- (13) Mango
- (14) Pasador de soporte
- (15) Bisagra europea
- (16) Bloqueo de leva
- (17) Etiqueta de advertencia

Página 10

1.1 Adjunte (1) a (A), (B), (C), (D), (E) y (F) como se ilustra.

1.2 Inserte (3) en (B) y (E) como se ilustra.

Página 11

2.1 Conecte (1) a (M) y (N) como se ilustra.

2.2 Inserte (3) en (H), (K), (M) y (N) como se ilustra.

Página 12

3.1 Inserte (4) en (U), (V), (W) y (X) como se ilustra.

Página 13

4.1 Conecte (1) a (Q), (R), (T) y (S) como se ilustra.

4.2 Inserte (3) en (Q), (R), (T) y (S) como se ilustra.

4.3 Conecte (15) a (Q) y (R) con (7) como se ilustra.

Página 14

5.1 Conecte (E), (D) y (F) como se ilustra.

5.2 Conecte (6) a (G), (H) e (I) como se ilustra.

5.3 Conecte (H) a (G) e (I) como se ilustra.

Página 15

- 6.1 Conecte (B) a (A) y (C) como se ilustra.
- 6.2 Conecte (U) a (A) y (B) con (16) como se ilustra.
- 6.3 Conecte (V) a (B) y (C) con (16) como se ilustra.

Página 16

- 7.1 Conecte (11) a (A), (B) y (C), con (10) como se ilustra.
- 7.2 Conecte (Y) a (A), (B) y (C) como se ilustra.

PRECAUCIÓN: No apriete demasiado el tubo de soporte para evitar dañar la placa.

Página 17

- 8.1 Inserte (2) en (U) y (V) como se ilustra.
- 8.2 Conecte (D), (E) y (F) a la muestra en el paso anterior con (8) y (9) como se ilustra.

Página 18

- 9.1 Conecte (K) a (T) y (S) con (16) como se ilustra.
- 9.2 Conecte (L) a (M) y (N) con (16) como se ilustra.
- 9.3 Conecte (K) - (S) - (T) a (L) - (M) - (N) con (16) como se ilustra.

Página 19

- 10.1 Adjunte la muestra en el paso (9) a (D), (E) y (F) con (16) como se ilustra.

Página 20

- 11.1 Adjuntar (W) a (Q); (X) a (R) con (16) como se ilustra.

Página 21

- 12.1 Adjunte (Q) - (W) y (R) - (X) a la muestra en el paso 10 con (16) como se ilustra.

Página 22

- 13.1 Fije (Z) al marco con (7) como se ilustra.

Nota: Verifique y apriete todos los tornillos en este paso.

Página 23

- 14.1 Adjunte (G), (H) e (I) a la muestra del paso anterior con (8) como se ilustra.

Nota: Verifique y apriete todos los tornillos en este paso.

ADVERTENCIA: Riesgo de muerte o lesiones graves. Esta superficie debe colocarse contra una pared fija al menos tan alta como un televisor.

Página 24

- 15.1 Inserte (14) en el marco como se ilustra.
- 15.2 Coloque (J) en el pasador del estante (14) como se ilustra.

Página 25

- 16.1 Adjunte (O), (P) a la muestra del paso anterior con (7) como se ilustra.
- 16.2 Conecte (13) a (O), (P) con (5) como se ilustra.

Página 26

Instrucción de ajuste de la bisagra de la puerta

Página 27

ADVERTENCIA DE SEGURIDAD PARA CHIMENEAS:

Si no se sigue la información del manual de funcionamiento de firepalce, una descarga eléctrica o un incendio pueden provocar daños a la propiedad, lesiones personales o la muerte.

RIESGO DE PROPINAS:

Riesgo de muerte o lesiones graves. Esta unidad debe colocarse contra una pared fija al menos tan alta como un televisor.

Página 28

CARGA MAXIMA

Esta unidad ha sido diseñada para soportar la carga máxima anotada. El exceder estos límites puede causar inestabilidad, colapsarse y/o causar serias lesiones.

ADVERTENCIA: aplique la etiqueta de advertencia de TV a su unidad para que siempre tenga los límites de peso y tamaño de TV del modelo.

Tamaño máximo del televisor: pantalla plana de 70 ", 120 libras / 54,5 kg.

Página 29

Registre su producto para recibir lo siguiente:

- * Detalles de nuevas tendencias - Vistazo a lo nuevo
- * Encuestas - aloc su voz entre su comunidad
- * Códigos de ofertas y descuentos exclusivos
- * Fácil y rápido servicio de partes de remplace

Para registrar su producto, visite ameriwoodhome.com

Clasificación de 5 estrellas

Visite el sitio web de su distribuidor local, califique el producto que compró y déjenos sus comentarios.

Nos gustaría enviar un gran "Agradecimiento" a todos nuestros clientes por tomarse el tiempo de ensamblar este producto de Ameriwood Home, y por darnos sus valiosos comentarios.

Gracias

Couverture Avant

CE LIVRET D'INSTRUCTION CONTIENT DES INFORMATIONS **IMPORTANTES** SUR LA SÉCURITÉ. VEUILLEZ LIRE ET GARDER POUR UNE RÉFÉRENCE FUTURE

Ne retournez pas ce produit! Contactez notre équipe de service à la clientèle amicale d'abord pour obtenir de l'aide.

Appelez-nous: 1-800-489-3351 (sans frais) du Lundi au Vendredi de 9h à 17h Heure Centrale

Visitez: www.ameriwoodhome.com

ATTENTION

Le meuble peut basculer et causer des blessures graves ou la mort.

Ancrer le meuble à une planche murale dans le mur (si indiqué).

Ne laissez pas les enfants grimper sur le meuble.

Placez les articles lourds sur les étagères ou dans les tiroirs inférieurs.

Astuces Utiles (page 2)

-Ouvrez votre article dans la zone que vous prévoyez de le garder pour moins de levage lourd

-Identifier, trier et compter les pièces avant d'essayer d'assembler

-Les goujons de compression sont taraudés avec un Marteau

-Les glissières sont marquées d'un R (droit) et d'un L (gauche) pour un bon placement

-Assurez-vous toujours de faire face la pointe situé sur le haut de la Serrure de Came vers le bord extérieur

-Utiliser tous les clous fournis pour le panneau arrière et les répartir également

-Le panneau arrière doit être utilisé pour vous assurer que votre appareil est robuste

-N'utilisez pas de produits chimiques agressifs ou de nettoyeurs abrasifs sur cet appareil

-Ne jamais pousser, tirer, ou faire glisser votre meuble

Avant de Commencer (page 3)

-Lisez attentivement chaque étape et suivez le bon ordre

-Séparez et comptez toutes vos pièces et matériaux

-Donnez-vous suffisamment de place pour l'assemblage

-Avoir les outils suivants: tournevis à tête plate, #2 tournevis Phillips, et Marteau

-Attention: Si vous utilisez une perceuse électrique ou un tournevis électrique pour visser, veillez à ralentir et arrêter lorsque la vis est bien serrée. Le non-respect de cette consigne peut endommager la vis.

Système de Fixation de Came (page 3)

Ce Système de Fixation de Came sera utilisé tout au long de l'assemblage

Identification des matériaux (Page 4-7)

Pas de taille réelle

- (A) EN HAUT À GAUCHE
- (B) HAUT DU MILIEU
- (C) HAUT DROIT
- (D) ÉTAGÈRE GAUCHE
- (E) ÉTAGÈRE DU MILIEU
- (F) ÉTAGÈRE DE DROITE
- (G) EN BAS À GAUCHE
- (H) MILIEU EN BAS
- (I) EN BAS À DROITE
- (J) TABLETTE AJUSTABLE
- (K) PANNEAU DE SOUTIEN
- (L) TABLIER SUPÉRIEUR
- (M) TABLIER GAUCHE
- (N) TABLIER DROIT
- (O) PORTE GAUCHE
- (P) PORTE DROITE
- (Q) PANNEAU LATÉRAL GAUCHE
- (R) PANNEAU CTÉ DROIT
- (S) PAROIS GAUCHE
- (T) CLOISON DROITE
- (U) PANNEAU SUPÉRIEUR ARRIÈRE GAUCHE
- (V) PANNEAU SUPÉRIEUR ARRIÈRE DROIT
- (W) PANNEAU DORSAL INFÉRIEUR GAUCHE
- (X) PANNEAU INFÉRIEUR DORSAL DROIT
- (Y) TUBE DE SUPPORT
- (Z) ENCASTRABLE DE FOYER

Liste des pièces (Page 8)

Taille réelle

- (1) Boulon à came
- (2) Cheville en bois
- (3) Cheville en bois
- (4) Cheville en bois
- (5) Boulon
- (6) glisse d'amure
- (7) Vis
- (8) Vis
- (9) Boulon
- (10) Boulon

Liste des pièces (Page 9)

Pas de taille réelle

- (11) Plaque de métal
- (12) Clé hexagonale
- (13) Poignée
- (14) Goupille de support
- (15) Euro charnière
- (16) Serrure à came
- (17) Étiquette d'avertissement

Page 10

1.1 Attachez (1) à (A), (B), (C), (D), (E) et (F) comme illustré.

1.2 Insérez (3) à (B) et (E) comme illustré.

Page 11

2.1 Fixez (1) à (M) et (N) comme illustré.

2.2 Insérez (3) à (H), (K), (M) et (N) comme illustré.

Page 12

3.1 Insérez (4) à (U), (V), (W) et (X) comme illustré.

Page 13

4.1 Attachez (1) à (Q), (R), (T) et (S) comme illustré.

4.2 Insérez (3) à (Q), (R), (T) et (S) comme illustré.

4.3 Fixez (15) à (Q) et (R) avec (7) comme illustré.

Page 14

5.1 Connectez (E), (D) et (F) comme illustré.

5.2 Fixez (6) à (G), (H) et (I) comme illustré.

5.3 Connectez (H) à (G) et (I) comme illustré.

Page 15

- 6.1 Connectez (B) à (A) et (C) comme illustré.
- 6.2 Fixez (U) à (A) et (B) avec (16) comme illustré.
- 6.3 Fixez (V) à (B) et (C) avec (16) comme illustré.

Page 16

- 7.1 Fixez (11) à (A), (B) et (C), avec (10) comme illustré.
- 7.2 Fixez (Y) à (A), (B) et (C) comme illustré.

ATTENTION : Ne serrez pas trop le tube de support pour éviter d'endommager la carte.

Page 17

- 8.1 Insérez (2) à (U) et (V) comme illustré.
- 8.2 Attachez (D), (E) et (F) à l'échantillon à l'étape précédente avec (8) et (9) comme illustré.

Page 18

- 9.1 Attachez (K) à (T) et (S) avec (16) comme illustré.
- 9.2 Fixez (L) à (M) et (N) avec (16) comme illustré.
- 9.3 Fixez (K)-(S)-(T) à (L)-(M)-(N) avec (16) comme illustré.

Page 19

- 10.1 Attachez l'échantillon à l'étape (9) à (D), (E) et (F) avec (16) comme illustré.

Page 20

- 11.1 Joindre (W) à (Q); (X) à (R) avec (16) comme illustré.

Page 21

- 12.1 Attachez (Q)-(W) et (R)-(X) à l'échantillon à l'étape 10 avec (16) comme illustré.

Page 22

- 13.1 Fixez (Z) au cadre avec (7) comme illustré.
- Remarque : veuillez vérifier et serrer toutes les vis dans cette étape.

Page 23

- 14.1 Attachez (G), (H) et (I) à l'échantillon de l'étape précédente avec (8) comme illustré.
- Remarque : veuillez vérifier et serrer toutes les vis dans cette étape.
- AVERTISSEMENT : risque de mort ou de blessures graves. Cette surface doit être placée contre un mur fixe au moins aussi haut que la télévision

Page 24

- 15.1 Insérez (14) dans le cadre comme illustré.
- 15.2 Mettez (J) sur la tige de la tablette (14) comme illustré.

Page 25

- 16.1 Attachez (O), (P) à l'échantillon de l'étape précédente avec (7) comme illustré.
- 16.2 Fixez (13) à (O), (P) avec (5) comme illustré.

Page 26

Instruction de réglage de la charnière de porte

Page 27

AVERTISSEMENT DE SÉCURITÉ POUR LE FOYER :

Si les informations contenues dans le manuel d'utilisation du fireplace ne sont pas suivies, un choc électrique ou un incendie peut entraîner des dommages matériels, des blessures corporelles ou la mort.

RISQUE DE BASCULEMENT :

Risque de mort ou de blessures graves. Cet appareil doit être placé contre un mur fixe au moins aussi haut que la télévision.

Page 28

CHARGES MAXIMALES

Ce meuble a été conçu pour supporter les charges maximales indiquées. En excédant ces limites de charge, le meuble pourrait devenir instable, s'effondrer, et/ou causer des blessures graves.

AVERTISSEMENT: Appliquez l'étiquette d'avertissement du téléviseur sur votre appareil afin d'avoir toujours les limites de poids et de taille du téléviseur du modèle.

Taille maximale du téléviseur : écran plat 70", 120 lbs/54,5 kg.

Page 29

Enregistrez votre produit pour recevoir les éléments suivantes:

- * Détails sur les nouvelles tendances - un aperçu sur les nouveautés
- * Sondages - avoir une voix au sein de notre communauté
- * Offres exclusives et codes promo
- * Service de pièces de rechange rapide et facile

Pour enregistrer votre produit, visitez ameriwoodhome.com

5 Étoiles

Visitez le site Web de votre détaillant local, évaluez le produit que vous avez acheté et laissez-nous vos commentaires !

Nous tenons à offrir un grand "Merci" à tous nos clients pour avoir pris le temps d'assembler ce produit "Ameriwood Home", et de nous donner vos commentaires précieux.

Merci